

Panasonic

Air conditioner

Installation Instruction

ACXF60-46970

MODEL NO. :-
CS/CU-NZ25, NZ35, NZ50YKE Series.

Required tools for Installation Works

- | | |
|--|----------------------|
| 1 Phillips screw driver | 12 Megameter |
| 2 Level gauge | 13 Multimeter |
| 3 Electric drill, hole core drill (ø70 mm) | 14 Torque wrench |
| 4 Hexagonal wrench (4 mm) | 18 Nmm (1.8 kgf·m) |
| 5 Spanner | 42 Nmm (4.3 kgf·m) |
| 6 Pipe cutter | 55 Nmm (5.6 kgf·m) |
| 7 Reamer | 65 Nmm (6.6 kgf·m) |
| 8 Knife | 100 Nmm (10.2 kgf·m) |
| 9 Gas leak detector | 15 Vacuum pump |
| 10 Measuring tape | 16 Gauge manifold |
| 11 Thermometer | |

Refer to National, State, Territory and local legislation, regulations, codes, installation & operation manuals, before the installation, maintenance and/or service of this product.

SAFETY PRECAUTIONS

- Read the following "SAFETY PRECAUTIONS" carefully before installation.
- Electrical work must be installed by a licensed electrician. Be sure to use the correct rating of the power plug and main circuit for the model to be installed.
- The caution items stated here must be followed because these important contents are related to safety. The meaning of each indication used is as below. Incorrect installation due to ignoring of the instruction will cause harm or damage, and the seriousness is classified by the following indications.

	WARNING	This indication shows the possibility of causing death or serious injury.
	CAUTION	This indication shows the possibility of causing injury or damage to properties only.
		Symbol with white background denotes item that is PROHIBITED.
		Symbol with dark background denotes item that must be carried out.

- Carry out test running to confirm that no abnormality occurs after the installation. Then, explain to user the operation, care and maintenance as stated in instructions. Please remind the customer to keep the operating instructions for future reference.

WARNING

- Do not use means to accelerate the defrosting process or to clean, other than those recommended by the manufacturer. Any unfit method or using incompatible material may cause product damage, burst and serious injury.
- Do not install outdoor unit near handrail of veranda. When installing air-conditioner unit on veranda of a high rise building, child may climb up to outdoor unit and cross over the handrail causing an accident.
- Do not use unspecified cord, modified cord, joint cord or extension cord for power supply cord. Do not share the single outlet with other electrical appliances. Poor contact, poor insulation or over current will cause electrical shock or fire.
- Do not tie up the power supply cord into a bundle by hand. Abnormal temperature rise on power supply cord may happen.
- Do not insert your fingers or other objects into the unit, high speed rotating fan may cause injury.
- Do not sit or step on the unit, you may fall down accidentally.
- Keep plastic bag (packaging material) away from small children, it may cling to nose and mouth and prevent breathing.
- When installing or relocating air conditioner, do not let any substance other than the specified refrigerant, eg. air etc. mix into refrigeration cycle (piping). Mixing of air etc. will cause abnormal high pressure in refrigeration cycle and result in explosion, injury etc.
- Do not pierce or burn as the appliance is pressurized. Do not expose the appliance to heat, flame, sparks, or other sources of ignition. Else, it may explode and cause injury or death.
- Do not add or replace refrigerant other than specified type. It may cause product damage, burst and injury etc.

- For R32/R410A model, use piping, flare nut and tools which is specified for R32/R410A refrigerant. Using of existing (R22) piping, flare nut and tools may cause abnormally high pressure in the refrigerant cycle (piping), and possibly result in explosion and injury.
- For R32 and R410A, the same flare nut on the outdoor unit side and pipe can be used.
- Since the working pressure for R32/R410A is higher than that of refrigerant R22 model, replacing conventional piping and flare nuts on the outdoor unit side are recommended.
- If reuse piping is unavoidable, refer to instruction "IN CASE OF REUSING EXISTING REFRIGERANT PIPING"
- Thickness for copper pipes used with R32/R410A must be more than 0.8 mm. Never use copper pipes thinner than 0.8 mm.
- It is desirable that the amount of residual oil less than 40 mg/10 m.

- Engage authorized dealer or specialist for installation. If installation done by the user is incorrect, it will cause water leakage, electrical shock or fire.
- For refrigeration system work, install according to this installation instructions strictly. If installation is defective, it will cause water leakage, electrical shock or fire.
- Use the attached accessories parts and specified parts for installation. Otherwise, it will cause the set to fall, water leakage, fire or electrical shock.
- Install at a strong and firm location which is able to withstand weight of the set. If the strength is not enough or installation is not properly done, the set will drop and cause injury.
- For electrical work, follow the national regulation, legislation and this installation instructions. An independent circuit and single outlet must be used. If electrical circuit capacity is not enough or defect found in the electrical work, it will cause electrical shock or fire.
- Do not use joint cable for indoor / outdoor connection cable. Use the specified indoor/outdoor connection cable, refer to instruction ⑤ **CONNECT THE CABLE TO THE INDOOR UNIT** and connect tightly for indoor/outdoor connection. Clamp the cable so that no external force will have impact on the terminal. If connection or fixing is not perfect, it will cause heat up or fire at the connection.
- Wire routing must be properly arranged so that control board cover is fixed properly. If control board cover is not fixed perfectly, it will cause fire or electrical shock.
- This equipment is strongly recommended to be installed with Earth Leakage Circuit Breaker (ELCB) or Residual Current Device (RCD), with sensitivity of 30 mA at 0.1 sec or less. Otherwise, it may cause electrical shock and fire in case of insulation breakdown.
- During installation, install the refrigerant piping properly before running the compressor. Operation of compressor without fixing refrigeration piping and valves at opened position will cause suck-in of air, abnormal high pressure in refrigeration cycle and result in explosion, injury etc.
- During pump down operation, stop the compressor before removing the refrigeration piping. Removal of refrigeration piping while compressor is operating and valves are opened will cause suck-in of air, abnormal high pressure in refrigeration cycle and result in explosion, injury etc.
- Tighten the flare nut with torque wrench according to specified method. If the flare nut is over-tightened, after a long period, the flare may break and cause refrigerant gas leakage.
- After completion of installation, confirm there is no leakage of refrigerant gas. It may generate toxic gas when the refrigerant contacts with fire.
- Ventilate if there is refrigerant gas leakage during operation. It may cause toxic gas when the refrigerant contacts with fire.
- Be aware that refrigerants may not contain an odor.
- This equipment must be properly earthed. Earth line must not be connected to gas pipe, water pipe, earth of lightning rod and telephone. Otherwise, it may cause electrical shock in case of equipment breakdown or insulation breakdown.

CAUTION

- Do not install the unit in a place where leakage of flammable gas may occur. In case gas leaks and accumulates at surrounding of the unit, it may cause fire.
- Prevent liquid or vapor from entering sumps or sewers since vapor is heavier than air and may form sulfating atmospheres.
- Do not release refrigerant during piping work for installation, re-installation and during repairing refrigeration parts. Take care of the liquid refrigerant, it may cause frostbite.
- Do not install this appliance in a laundry room or other location where water may drip from the ceiling, etc.
- Do not touch the sharp aluminum film, sharp parts may cause injury.
- Carry out drainage piping as mentioned in installation instructions. If drainage is not perfect, water may enter the room and damage the furniture.
- Select an installation location which is easy for maintenance. Incorrect installation, service or repair of this air conditioner may increase the risk of rupture and this may result in loss damage or injury and/or property.
- Power supply connection to the room air conditioner. Use power supply cord 3 x 1.5 mm² (1.0 - 1.5HP), 3 x 2.5 mm² (2.0HP) type designation 60245 IEC 57 or heavier cord. Connect the power supply cord of the air conditioner to the mains using one of the following method. Power supply point should be in easily accessible place for power disconnection in case of emergency. In some countries, permanent connection of this air conditioner to the power supply is prohibited.
 - Power supply connection to the receptacle using power plug. Use an approved 1516 A (1.0 - 1.5HP), 16 A (2.0HP), power plug with earth pin for the connection to the socket.
 - Power supply connection to a circuit breaker for the permanent connection. Use an approved 16 A (1.0 - 2.0HP), circuit breaker for the permanent connection. It must be a double pole switch with a minimum 3.0 mm contact gap.
- Installation work. It may need two people to carry out the installation work.
- Keep any required ventilation openings clear of obstruction.

PRECAUTION FOR USING R32 REFRIGERANT

WARNING

- When connecting flare at indoor side, make sure that the flare connection is used only once, if torqued up and released, the flare must be remade. Once the flare connection was torqued up correctly and leak test was made, thoroughly clean and dry the flare surface to remove oil, dirt and grease by following instructions of silicone sealant. Apply neutral cure (alkoxy type) & ammonia-free silicone sealant that is non-corrosive to copper & brass to the external of the flared connection to prevent the ingress of moisture on both the gas & liquid sides. (Moisture may cause freezing and premature failure of the connection).
- The appliance shall be stored, installed and operated in a well ventilated room with indoor floor area larger than A_{min} (m²) (refer Table A) and without any continuously operating ignition source. Keep away from open flames, any operating gas appliances or any operating electric heater. Else, it may explode and cause injury or death.
- The mixing of different refrigerants within a system is prohibited. Models that use refrigerant R32 and R410A have a different charging port thread diameter to prevent erroneous charging with refrigerant R22 and for safety. Therefore, check beforehand. (The charging port thread diameter for R32 and R410A is 12.7 mm (1/2 inch).)
- Ensure that foreign matter (oil, water, etc.) does not enter the piping. Also, when storing the piping, securely seal the opening by pinching, taping, etc. (Handling of R32 is similar to R410A.)
- Operation, maintenance, repairing and refrigerant recovery should be carried out by trained and certified personnel in the use of flammable refrigerants and as recommended by the manufacturer. Any personnel conducting an operation, servicing or maintenance on a system or associated parts of the equipment should be trained and certified.
- Any part of refrigerating circuit (evaporators, air coolers, AHU, condensers or liquid receivers) or piping should not be located in the proximity of heat sources, open flames, operating gas appliance or an operating electric heater.
- The user/owner or their authorized representative shall regularly check the alarms, mechanical ventilation and detectors, at least once a year, when as required by national regulations, to ensure their correct functioning.
- A logbook shall be maintained. The results of these checks shall be recorded in the logbook.
- In case of ventilations in occupied spaces shall be checked to confirm no obstruction.
- Before a new refrigerating system is put into service, the person responsible for placing the system in operation should ensure that trained and certified operating personnel are instructed on the basis of the instruction manual about the construction, supervision, operation and maintenance of the refrigerating system, as well as the safety measures to be observed, and the properties and handling of the refrigerant used.
- The general requirement of trained and certified personnel are indicated as below:
 - Knowledge of legislation, regulations and standards relating to flammable refrigerants; and,
 - Detailed knowledge of and skills in handling flammable refrigerants, personal protective equipment, refrigerant leakage prevention, handling of cylinders, charging, leak detection, recovery and disposal; and,
 - Ability to understand and to apply in practice the requirements in the national legislation, regulations and Standards; and,
 - Continuously undergo regular and further training to maintain this expertise.
- Air-conditioner piping in the occupied space shall be installed in such a way to protect against accidental damage in operation and service.

- Precautions shall be taken to avoid excessive vibration or pulsation to refrigerating piping.
- Ensure protection devices, refrigerating piping and fittings are well protected against adverse environmental effects (such as the danger of water collecting and freezing in relief pipes or the accumulation of dirt and debris).
- Expansion and contraction of long runs piping in refrigerating systems shall be designed and installed securely (mounted and spaced area) to minimize the likelihood hydraulic shock damaging the system.
- Protect the refrigerating system from accidental rupture due to moving furniture or reconstruction activities.
- To ensure no leaking, field-made refrigerant joints indoors shall be tightness tested. The test method shall have a sensitivity of 5 grams per year of refrigerant or better under a pressure of at least 0.25 times the maximum allowable pressure (≥1.04 MPa, max 4.15 MPa). No leak shall be detected.

CAUTION

- General
 - Must ensure the installation of pipe-work shall be kept to a minimum. Avoid use dented pipe and do not allow acute bending.
 - Must ensure that pipe-work shall be protected from physical damage.
 - Must comply with national gas regulations, state municipal rules and legislation. Notify relevant authorities in accordance with all applicable regulations.
 - Must ensure mechanical connections be accessible for maintenance purposes.
 - In cases that require mechanical connections, they shall be made in accordance with the manufacturer's instructions.
 - When disposal of the product, do follow to the precautions in #11 and comply with national regulations.
 - In case of field charge, the effect on refrigerant charge caused by the different pipe length has to be quantified, measured and labelled.
 - Always contact to local municipal offices for proper handling.
 - Ensure the actual refrigerant charge is in accordance with the room size within which the refrigerant containing parts are installed.
 - Ensure refrigerant charge not to leak.
 - Wear appropriate protective equipment, including respiratory protection, as conditions warrant.
 - Keep all sources of ignition and hot metal surfaces away.
- Servicing
 - 2-1. Qualification of workers
 - Any qualified person who is involved with working on or breaking into a refrigerant circuit should hold a current valid certificate from an industry-accredited assessment authority, which authorizes their competence to handle refrigerants safely in accordance with an industry recognized assessment specification.
 - Servicing shall only be performed as recommended by the equipment manufacturer. Maintenance and repair requiring the assistance of other skilled personnel shall be carried out under the supervision of the person competent in the use of flammable refrigerants.
 - Servicing shall be performed only as recommended by the manufacturer.
 - The system is inspected, regularly supervised and maintained by a trained and certified service personnel who is employed by the person user or party responsible.
 - 2-2. Checks to the area
 - Prior to beginning work on systems containing flammable refrigerants, safety checks are necessary to ensure that the risk of ignition is minimised. For repair to the refrigerating system, the precautions in #2-3 to #2-7 must be followed before conducting work on the system.
 - 2-3. Work procedure
 - Work shall be undertaken under a controlled procedure so as to minimize the risk of a flammable gas or vapour being present while the work is being performed.
 - 2-4. General work area
 - All maintenance staff and others working in the local area shall be instructed and supervised on the nature of work being carried out.
 - Avoid working in confined spaces. Always ensure away from source, at least 2 meter of safety distance, or zoning of free space area of at least 2 meter in radius.
 - 2-5. Checking for presence of refrigerant
 - The area shall be checked with an appropriate refrigerant detector prior to and during work, to ensure the technician is aware of potentially flammable atmospheres.
 - Ensure that the leak detection equipment being used is suitable for use with flammable refrigerants, i.e. non sparking, adequately sealed or intrinsically safe.
 - In case of leakage/spillage happened, immediately ventilate area and stay upwind and away from spill/release.
 - In case of leakage/spillage happened, do notify persons down wind of the leaking/spill, isolate immediate hazard area and keep unauthorized personnel out.
 - 2-6. Presence of fire extinguisher
 - If any hot work is to be conducted on the refrigerating equipment or any associated parts, appropriate fire extinguishing equipment shall be available at hand.
 - Have a dry powder or CO₂ fire extinguisher adjacent to the charging area.
 - 2-7. No ignition sources
 - No person carrying out work in relation to a refrigerating system which involves exposing any pipe work that contains or has contained flammable refrigerant shall use any sources of ignition in such a manner that it may lead to the risk of fire or explosion. He/She must not be smoking when carrying out such work.
 - All possible ignition sources, including cigarette smoking, should be kept sufficiently far away from the site of installation, repairing, removing and disposal, during which flammable refrigerant can possibly be released to the surrounding space.
 - Prior to work taking place, the area around the equipment is to be surveyed to make sure that there are no flammable hazards or ignition risks.
 - 'No Smoking' signs shall be displayed.
 - 2-8. Ventilated area
 - Ensure that the area is in the open or that it is adequately ventilated before breaking into the system or conducting any hot work.
 - A degree of ventilation shall continue during the period that the work is carried out.
 - The ventilation should safely disperse any released refrigerant and preferably expel it externally into the atmosphere.
 - 2-9. Checks to the refrigerating equipment
 - Where electrical components are being changed, they shall be fit for the purpose and to the correct specification.
 - At all times the manufacturer's maintenance and service guidelines shall be followed.
 - If in doubt consult the manufacturer's technical department for assistance.
 - The following checks shall be applied to installations using flammable refrigerants.
 - The actual refrigerant charge shall be in accordance with the room size within which the refrigerant containing parts are installed.
 - The ventilation machinery and outlets are operating adequately and are not obstructed.
 - If an indirect refrigerating circuit is being used, the secondary circuit shall be checked for the presence of refrigerant.
 - Marking to the equipment containing flammable and legible. Markings and signs that are legible shall be corrected.
 - Refrigerating pipe or components are installed in a position where they are unlikely to be exposed to any substance which may corrode refrigerant containing components, unless the components are constructed of materials which are inherently resistant to being corroded or are properly protected against being so corroded.

- 2-10. Checks to electrical devices
 - Repair and maintenance to electrical components shall include initial safety checks and component inspection procedures.
 - Initial safety checks shall include but not limit to:
 - That capacitors are discharged; this shall be done in a safe manner to avoid possibility of sparking.
 - That there is no live electrical components and wiring exposed while charging, recovering or purging the system.
 - That there is continuity of earth bonding.
 - At all times the manufacturer's maintenance and service guidelines shall be followed.
 - If in doubt consult the manufacturer's technical department for assistance.
 - The following checks shall be applied to installations using flammable refrigerants.
 - The actual refrigerant charge shall be in accordance with the room size within which the refrigerant containing parts are installed.
 - The ventilation machinery and outlets are operating adequately and are not obstructed.
 - If an indirect refrigerating circuit is being used, the secondary circuit shall be checked for the presence of refrigerant.
 - Marking to the equipment containing flammable and legible. Markings and signs that are legible shall be corrected.
 - Refrigerating pipe or components are installed in a position where they are unlikely to be exposed to any substance which may corrode refrigerant containing components, unless the components are constructed of materials which are inherently resistant to being corroded or are properly protected against being so corroded.

- 2-11. Repair to sealed components
 - During repairs to sealed components, all electrical supplies shall be disconnected from the equipment being worked upon prior to any removal of sealed covers, etc.
 - If it is absolutely necessary to have an electrical supply to equipment during servicing, then a permanently operating form of leak detection shall be located at the most critical point to warn of a potentially hazardous situation.
 - Particular attention shall be paid to the following to ensure that by working on electrical components, the casing is not altered in such a way that the level of protection is affected. This shall include damage to cables, excessive number of connections, terminals not made to original specification, damage to seals, incorrect fitting of glands, etc.
- 2-12. Repair to intrinsically safe components
 - Do not apply any permanent inductive or capacitance loads to the circuit without ensuring that this will not exceed the permissible voltage and current permitted for the equipment in use.
 - Intrinsically safe components are the only types that can be worked on while live in the presence of a flammable atmosphere.
 - The test apparatus shall be at the correct rating.
 - Replace components only with parts specified by the manufacturer. Unspecified parts by manufacturer may result ignition of refrigerant in the atmosphere from a leak.
- 2-13. Cabling
 - Check that cabling will not be subject to wear, corrosion, excessive pressure, vibration, sharp edges or any other adverse environmental effects.
 - The check shall also take into account the effects of aging or continual vibration from sources such as compressors or fans.
- 2-14. Detection of flammable refrigerants
 - Under no circumstances shall potential sources of ignition be used in the searching or detection of refrigerant leaks.
 - A halide torch (or any other detector using a naked flame) shall not be used.
 - The following leak detection methods are deemed acceptable for all refrigerant systems.
 - No leaks shall be detected when using detection equipment with a sensitivity of 5 grams per year of refrigerant or better under a pressure of at least 0.25 times the maximum allowable pressure (≥1.04 MPa, max 4.15 MPa) for example, a universal sniffer.
 - Electronic leak detectors may be used to detect flammable refrigerants, but the sensitivity may not be adequate, or may need re-calibration. (Detection equipment shall be calibrated in a refrigerant-free area.)
 - Ensure that the detector is not a potential source of ignition and is suitable for the refrigerant used.
 - Leak detection equipment shall be set at a percentage of the LFL of the refrigerant and shall be calibrated to the refrigerant employed and the appropriate percentage of gas (25 % maximum) is confirmed.
 - Leak detection fluids are also suitable for use with most refrigerants, for example, bubble method and fluorescent method agents. The use of detergents containing chlorine shall be avoided as the chlorine may react with the refrigerant and corrode the copper pipe-work.
 - If a leak is suspected, all naked flames shall be removed/ extinguished.
 - If a leakage of refrigerant is found which requires brazing, all of the refrigerant shall be recovered from the system, or isolated (by means of shut off valves) in a part of the system remote from the leak. The precautions in #7 must be followed to remove the refrigerant.
- 2-15. Removal and evacuation
 - When breaking into the refrigerant circuit to make repairs – or for any other purpose – conventional procedures shall be used. However, it is important that best practice is followed since flammability is a consideration. The following procedure shall be achieved to:
 - remove refrigerant -> purge the circuit with inert gas -> evacuate -> purge with inert gas -> open the circuit by cutting or brazing

- 2-16. The refrigerant charge shall be recovered into the correct recovery cylinders.
 - The system shall be purged with OFN to render the appliance safe. (remark: OFN = oxygen free nitrogen, type of inert gas)
 - This process may need to be repeated several times.
 - Compressed air or oxygen shall not be used for this task.
 - Purging shall be achieved by breaking the vacuum in the system with OFN and continuing to fill until the working pressure is achieved, then venting to atmosphere, and finally pulling down to a vacuum.
 - This process shall be repeated until no refrigerant is within the system.
 - When the final OFN charge is used, the system shall be vented down to atmospheric pressure to enable work to take place.
 - This operation is absolutely vital if brazing operations on the pipe work are to take place.
 - Ensure that the outlet for the vacuum pump is not close to any potential ignition sources and there is ventilation available.
- 2-17. Charging procedures
 - In addition to conventional charging procedures, the following requirements shall be followed.
 - Ensure that contamination of different refrigerants does not occur when using charging equipment.
 - Hoses or lines shall be as short as possible to minimize the amount of refrigerant contained in them.
 - Cylinders shall be kept in an appropriate position according to the instructions.
 - Ensure that the refrigerating system is earthed prior to charging the system with refrigerant.
 - Label the system when charging is complete (if not already).
 - Extreme care shall be taken not to over fill the refrigerating system.
 - Prior to recharging the system it must be pressure tested with OFN (refer to #7).
 - The system shall be pressure tested on completion of charging but prior to commissioning.
 - A follow up leak test shall be carried out prior to leaving the site.
 - Electrostatic charge may accumulate and create a hazardous condition when charging and discharging the refrigerant.
 - To avoid fire or explosion, dissipate static electricity during transfer by grounding and bonding containers and equipment before charging/discharging.

- 2-18. Decommissioning
 - Before carrying out this procedure, it is essential that the technician is completely familiar with the equipment and all its details.
 - It is recommended good practice that all refrigerants are recovered safely.
 - Prior to the task being carried out, an oil and refrigerant sample shall be taken in case analysis is required prior to re-use of recovered refrigerant.
 - It is essential that electrical power is available before the task is commenced.
 - Become familiar with the equipment and its operation.
 - Isolate system electrically.
 - Before attempting the procedure ensure that:
 - mechanical handling equipment is available, if required, for handling refrigerant cylinders;
 - if personal protective equipment is available and being used correctly;
 - the recovery process is supervised and controlled by a competent person;
 - recovery equipment and cylinders conform to the appropriate standards.
 - Pump down refrigerant system, if possible.
 - If a vacuum is not possible, make a manifold so that refrigerant can be removed from various parts of the system.
 - Electrostatic charge may accumulate and create a hazardous condition when charging or discharging the refrigerant. To avoid fire or explosion, dissipate static electricity during transfer by grounding and bonding containers and equipment before charging/discharging.

- 2-19. Make sure that cylinder is situated on the scales before recovery takes place.
 - Start the recovery machine and operate in accordance with instructions.
 - Do not over fill cylinders. (No more than 80 % volume liquid charge).
 - Do not exceed the maximum working pressure of the cylinder, even temporarily.
 - When the cylinders have been filled correctly and the process completed, make sure that the cylinders and the equipment are removed from site promptly and all isolation valves on the equipment are closed off.
 - Recovered refrigerant shall not be charged into another refrigerating system unless it has been cleaned and checked.
- 2-20. Make sure that cylinder is situated on the scales before recovery takes place.
 - Start the recovery machine and operate in accordance with instructions.
 - Do not over fill cylinders. (No more than 80 % volume liquid charge).
 - Do not exceed the maximum working pressure of the cylinder, even temporarily.
 - When the cylinders have been filled correctly and the process completed, make sure that the cylinders and the equipment are removed from site promptly and all isolation valves on the equipment are closed off.
 - Recovered refrigerant shall not be charged into another refrigerating system unless it has been cleaned and checked.

10. Labeling
 - Equipment shall be labelled stating that it has been de-commissioned and emptied of refrigerant.
 - The label shall be dated and signed.
 - Ensure that there are labels on the equipment stating the equipment contains flammable refrigerant.
11. Recovery
 - When removing refrigerant from a system, either for servicing or decommissioning, it is recommended good practice that all refrigerants are removed safely.
 - When transferring refrigerant into cylinders, ensure that only appropriate refrigerant recovery cylinders are employed.
 - Ensure that the correct number of cylinders for holding the total system charge are available.
 - Do not mix refrigerants in recovery units and especially not in cylinders.
 - Cylinders shall be used as designated for the recovered refrigerant and labelled for that refrigerant (i.e. special cylinders for the recovery of refrigerant).
 - Cylinders shall be complete with pressure relief valve and associated shut-off valves in good working order.
 - Recovery cylinders are evacuated and, if possible, cooled before recovery occurs.
 - The recovery equipment shall be in good working order with a set of instructions concerning the equipment that is at hand and shall be suitable for the recovery of the recovery of flammable refrigerants.
 - In addition, a set of calibrated weighing scales shall be available and in good working order.
 - Hoses shall be complete with leak-free disconnect couplings and in good condition.
 - Before using the recovery machine, check that it is in satisfactory working order, has been properly maintained and that any associated electrical components are sealed to prevent ignition in the event of a refrigerant release. Consult manufacturer if in doubt.
 - The recovered refrigerant shall be returned to the refrigerant supplier in the correct recovery cylinder, and the relevant Waste Transfer Note arranged.
 - Chemical ventilation, ventilation openings shall be kept clear of obstruction.
 - If compressors or compressor oils are to be removed, ensure that they have been evacuated to an acceptable level to make certain that flammable refrigerant does not remain within the lubricant.
 - The evacuation process shall be carried out prior to returning the compressor to the suppliers.
 - Only electric heating to the compressor body shall be employed to accelerate this process.
 - When oil is drained from a system, it shall be carried out safely.

Explanation of symbols displayed on the indoor unit or outdoor unit.

	WARNING	This symbol shows that this equipment uses a flammable refrigerant. If the refrigerant is leaked, together with an external ignition source, there is a possibility of ignition.
	CAUTION	This symbol shows that the Installation Manual should be read carefully.
	CAUTION	This symbol shows that a service personnel should be handling this equipment with reference to the Installation Manual.
	CAUTION	This symbol shows that there is information included in the Operation Manual and/or Installation Manual.

Attached accessories

No.	Accessories part	Qty.	No.	Accessories part	Qty.
1	Installation plate	1	4	Battery	2
2	Installation plate fixing screw	5	5	Remote control holder	1
3	Remote Control	1	6	Remote control holder fixing screw	2

Applicable piping kit	Piping size	
	Gas	Liquid
CZ-3F5, 7BP	9.52 mm (3/8")	6.35 mm (1/4")
CZ-4F5, 7, 10BP	12.7 mm (1/2")	6.35 mm (1/4")
CZ-5F5, 7, 10BP	15.88 mm (5/8")	6.35 mm (1/4")

SELECT THE BEST LOCATION

- INDOOR UNIT**
 - Do not install the unit in excessive oil fume area such as kitchen, workshop and etc.
 - There should not be any heat source or steam near the unit.
 - There should not be any obstacles blocking the air circulation.
 - A place where air circulation in the room is good.
 - A place where drainage can be easily done.
 - A place where noise prevention is taken into consideration.
 - Do not install the unit near the doorway.
 - Ensure the spaces indicated by arrows from the wall, ceiling, fence or other obstacles.
 - Recommended installation height for outdoor unit is at 1.8 m or more from the floor.

OUTDOOR UNIT

- If an awning is built over the unit to prevent direct sunlight or rain, be careful that heat radiation from the condenser is not obstructed.
- There should not be any animal or plant which could be affected by hot air discharged.
- Keep the spaces indicated by arrows from wall, ceiling, fence or other obstacles.
- Do not place any obstacles which may cause a short circuit of the discharged air.
- If piping length is over the piping length for additional gas, additional refrigerant should be added as shown in the table.

Table A

Model	Capacity W (HP)	Piping size		Std. Length (m)	Max. Elevation (m)	Min. Piping Length (m)	Max. Piping Length (m)	Additional Refrigerant (g/m)	Piping Length for add. gas (m)	Max. Refrigerant Charge (kg)	Indoor A _{min} (m ²)
		Gas	Liquid								
NZ25***	1.0HP	9.52 mm (3/8")	6.35 mm (1/4")	10	3	20	10	7.5	0.95	Not applicable (*)	
NZ35***	1.5HP	12.70 mm (1/2")	6.35 mm (1/4")	5	10	3	20	10	7.5	0.95	Not applicable (*)
NZ50***	2.0HP	12.70 mm (1/2")	6.35 mm (1/4")	15	3	20	15	7.5	1.32	Not applicable (*)	

(*) Systems with total refrigerant charge, m_{tc}, lower than 1.84 kg are not subjected to any room area requirements.

Example: For NZ25***
If the unit is installed at 10 m distance, the quantity of additional refrigerant should be 25 g ... (10-7.5) m x 10 g/m = 25 g.

$$A_{min} = (m_{tc} / (2.5 \times (LFL)^{0.66} \times h_c))^{2.2} \quad \text{** not less than safety factor margin}$$

A_{min} = Required minimum room area, in m²
m_{tc} = Refrigerant charge in appliance, in kg
LFL = Lower flammability limit (0.307 kg/m³)
h_c = Installation height of the appliance (1.8 m for wall mounted)
SF = Safety factor with a value of 0.75

** The required minimum room area, A_{min}, shall also be governed by the safety factor margin formula below :

$$A_{min} = m_{tc} / (SF \times LFL \times h_c)$$

The higher value shall be taken when determining the room area.

Indoor/Outdoor Unit Installation Diagram

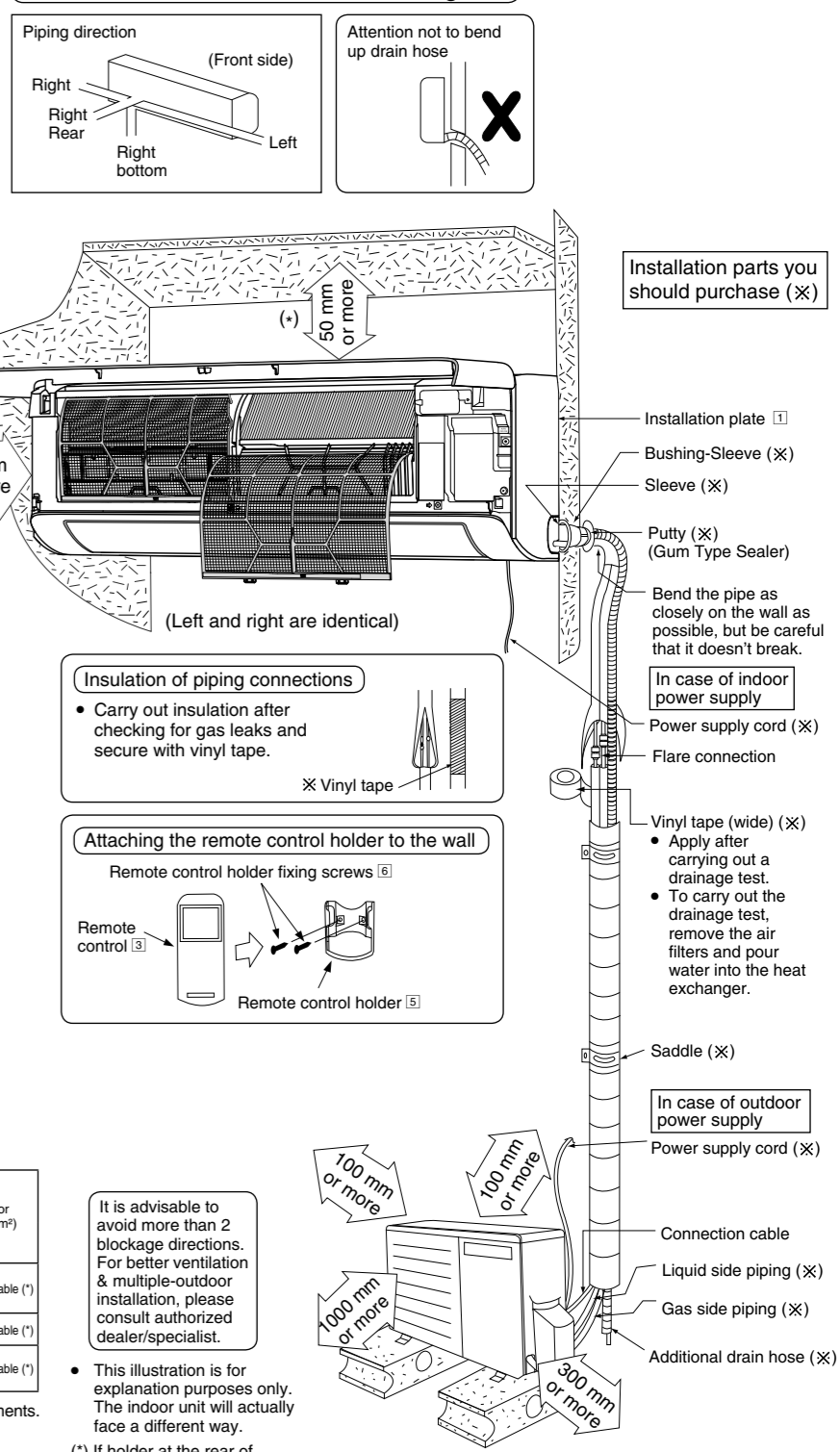

It is advisable to avoid more than 2 blockage directions. For better ventilation & multiple-outdoor installation, please contact authorized dealer/specialist.

INDOOR UNIT

1 SELECT THE BEST LOCATION

(Refer to "Select the best location" section)

2 HOW TO FIX INSTALLATION PLATE

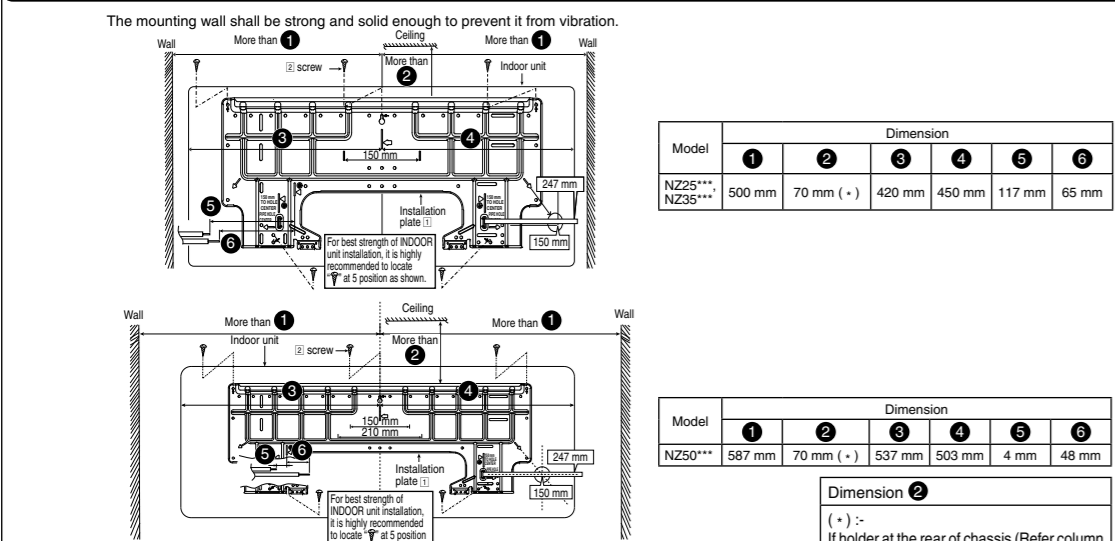

The center of installation plate should be at more than ① at right and left of the wall. The distance from installation plate edge to ceiling should be more than ②. From installation plate center to unit's left side is ③. From installation plate center to unit's right side is ④.

⑤ : For left side piping, piping connection for liquid should be about ⑤ from this line. For right side piping, piping connection for gas should be about ⑥ from this line.

- Mount the installation plate on the wall with 5 screws or more (at least 5 screws). (If mounting unit on the concrete wall, consider using anchor bolts.)
- Always mount the installation plate horizontally by aligning the marking-off line with the thread and using a level gauge.
- Drill the piping plate hole with $\phi 70$ mm hole-core drill.
- Line according to the left and right side of the installation plate. The meeting point of the extended line is the center of the hole. Another method is by putting measuring tape at position as shown in the diagram above. The hole center is obtained by measuring the distance namely 150 mm for left and right hole respectively (NZ25***, NZ35***). Drill the piping hole at either the right or the left and the hole should be slightly slanting to the outdoor side.

3 TO DRILL A HOLE IN THE WALL AND INSTALL A SLEEVE OF PIPING

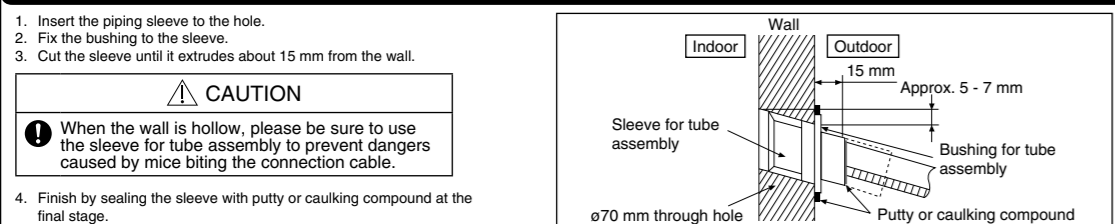

5 CONNECT THE CABLE TO THE INDOOR UNIT

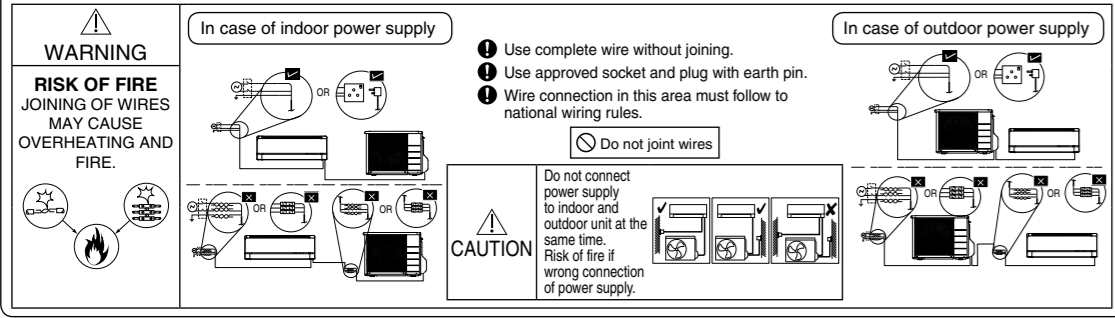
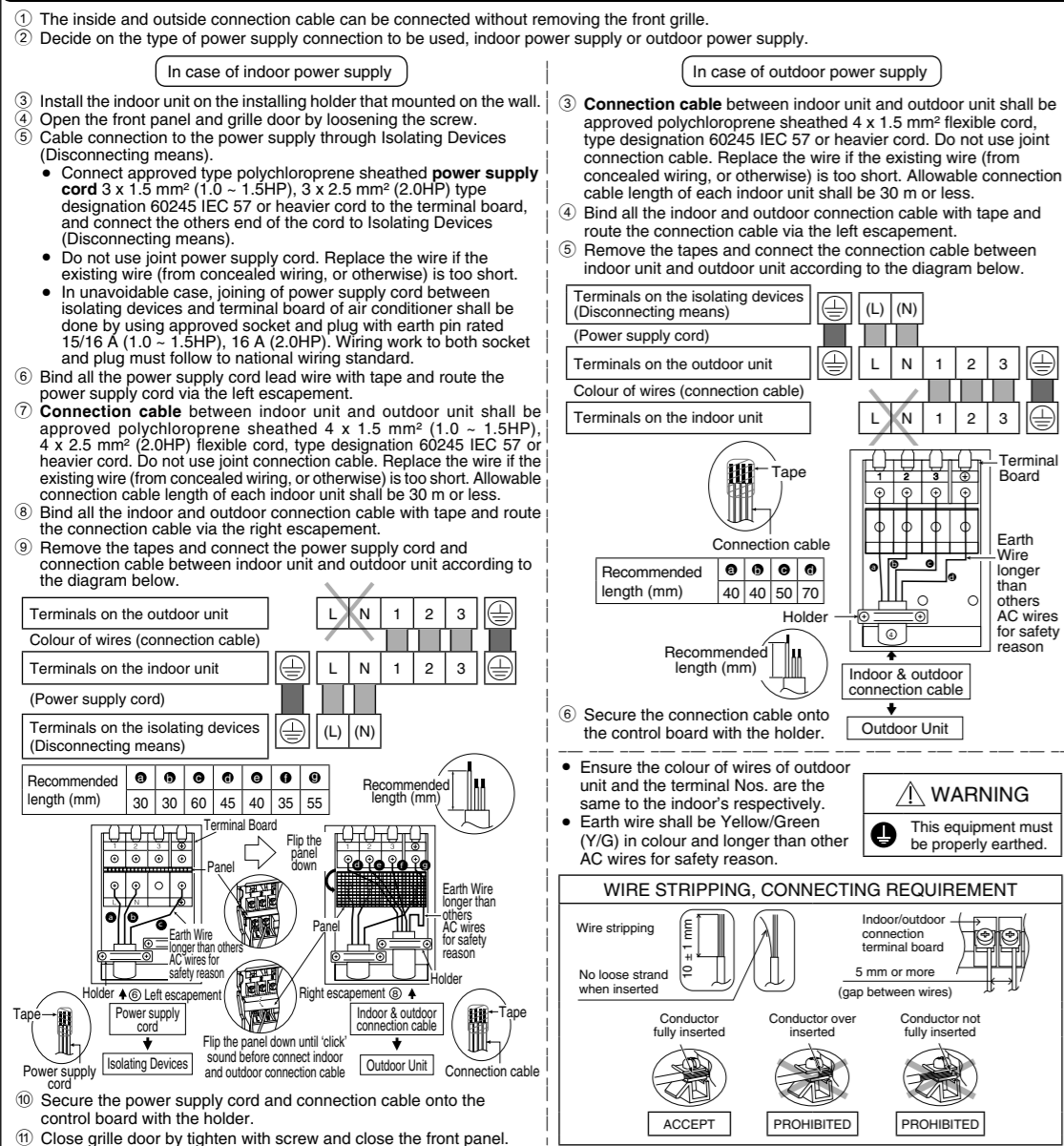

4 INDOOR UNIT INSTALLATION

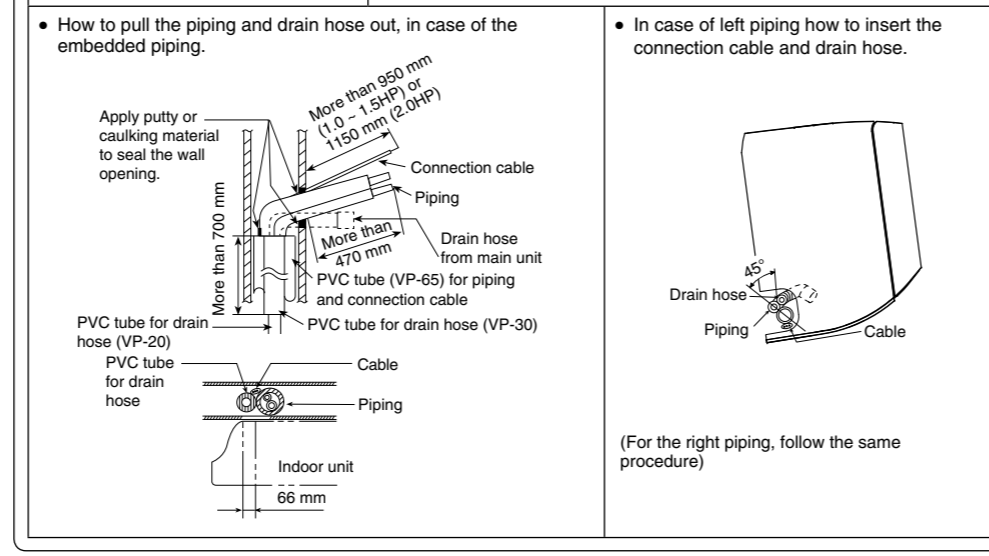
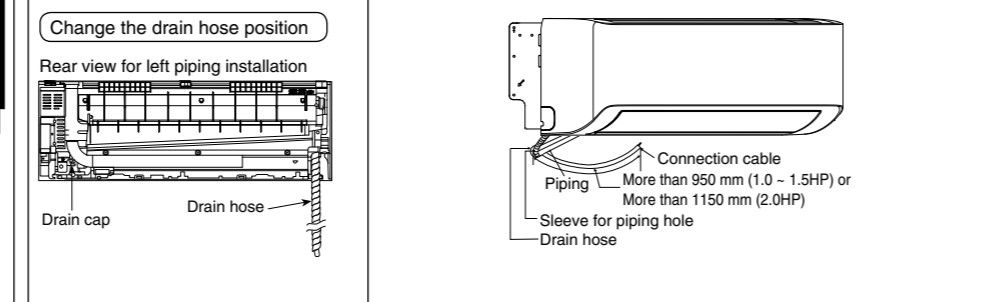
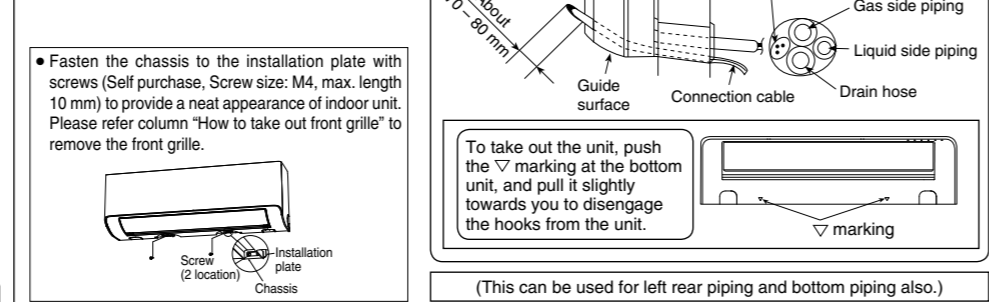
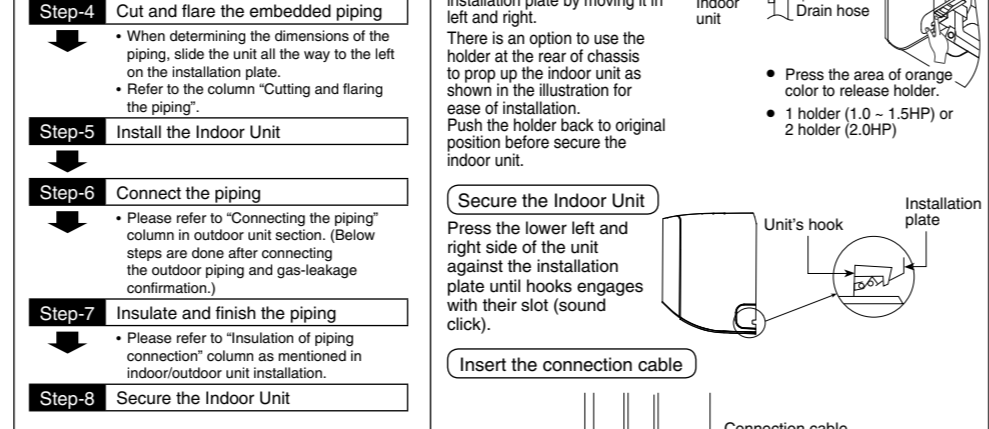
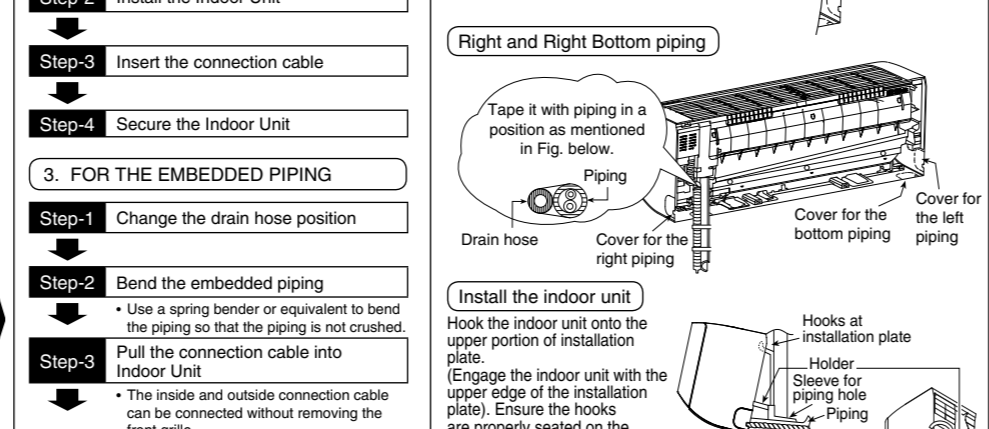
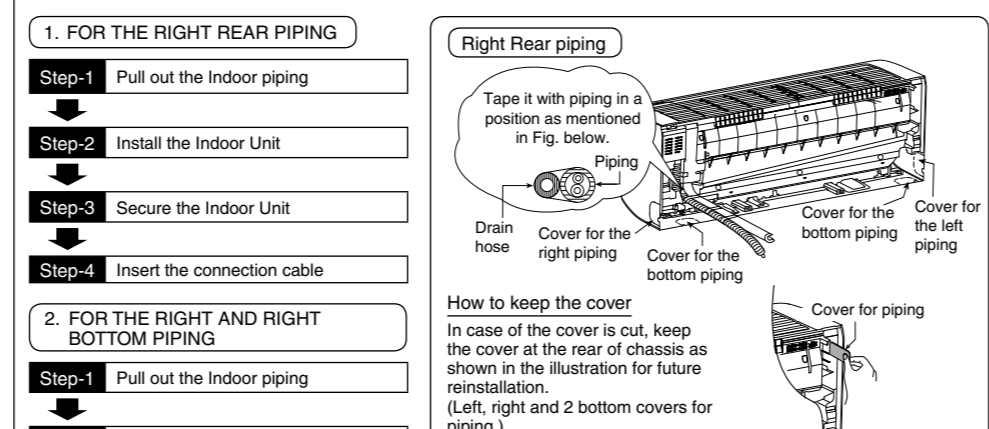
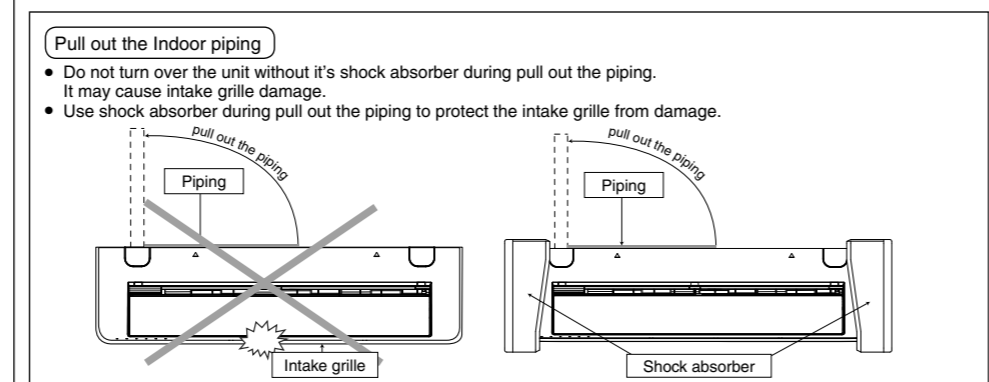

OUTDOOR UNIT

1 SELECT THE BEST LOCATION

(Refer to "Select the best location" section)

2 INSTALL THE OUTDOOR UNIT

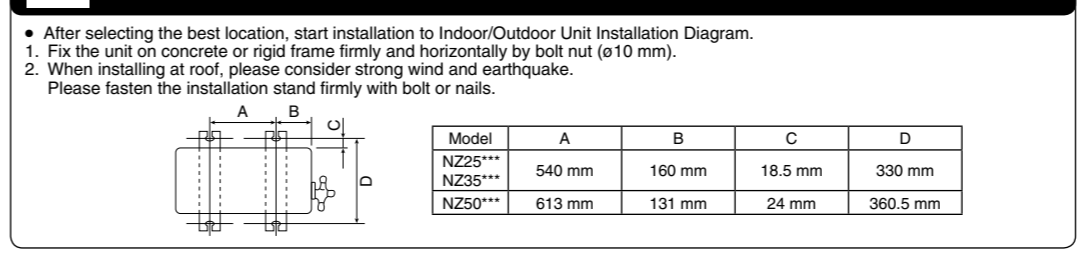

3 CONNECT THE PIPING

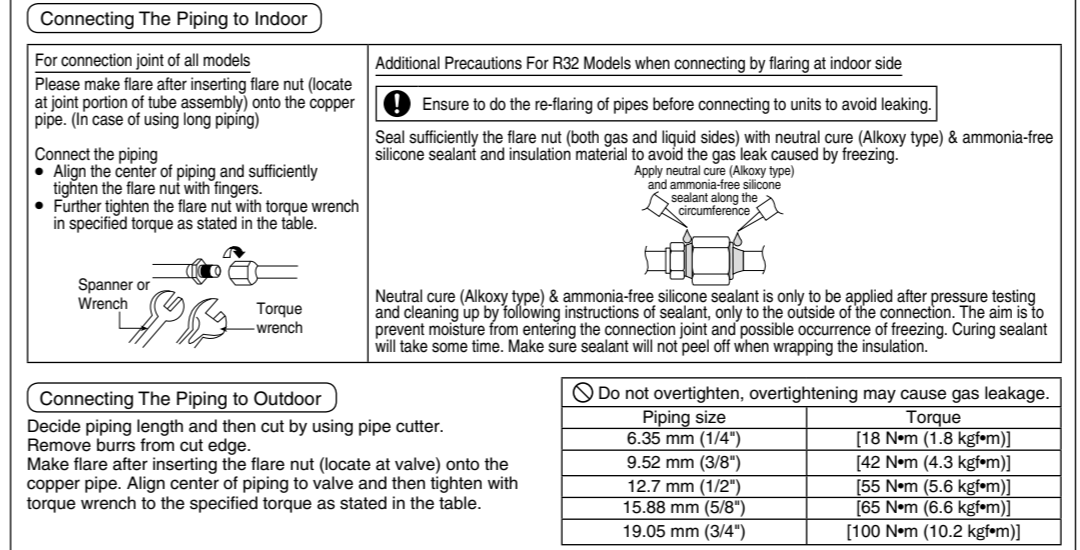

5 CONNECT THE CABLE TO THE OUTDOOR UNIT

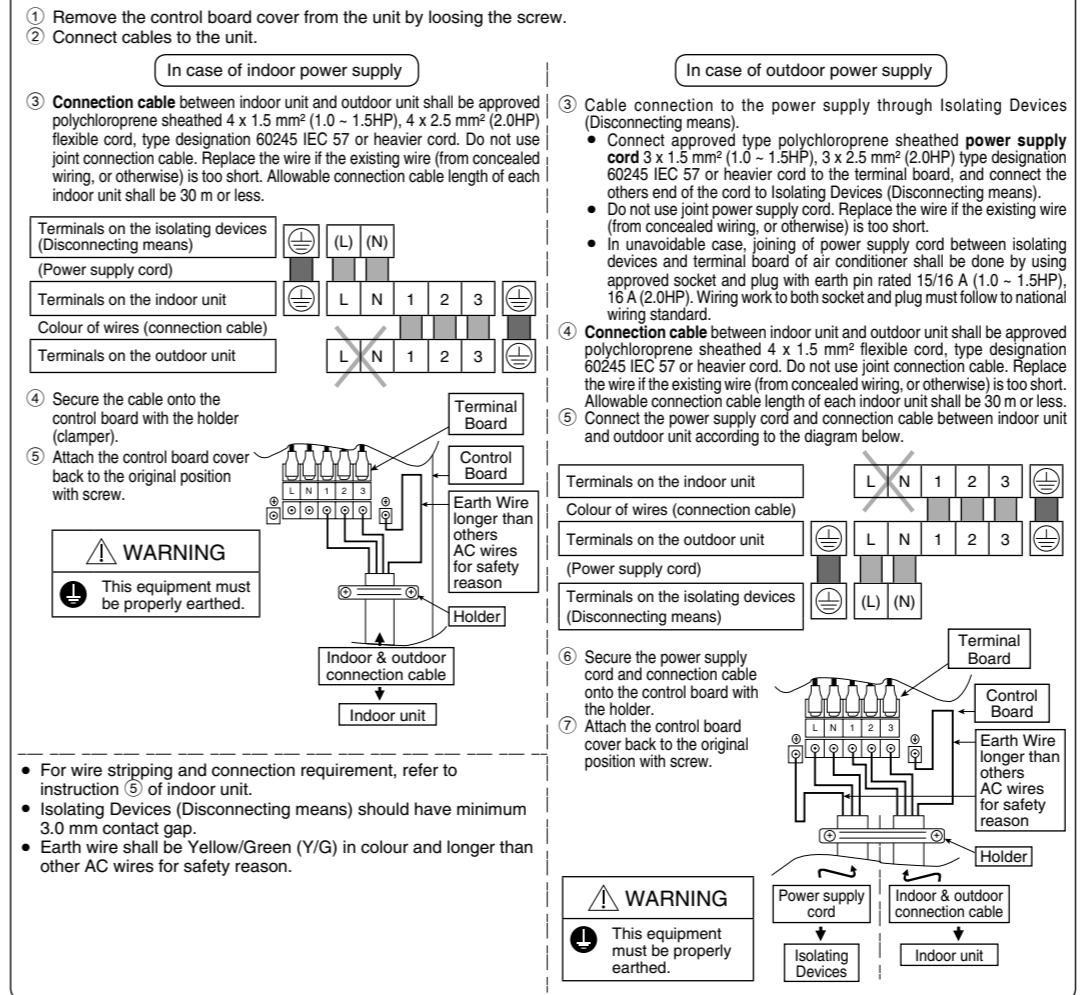

HOW TO TAKE OUT FRONT GRILLE

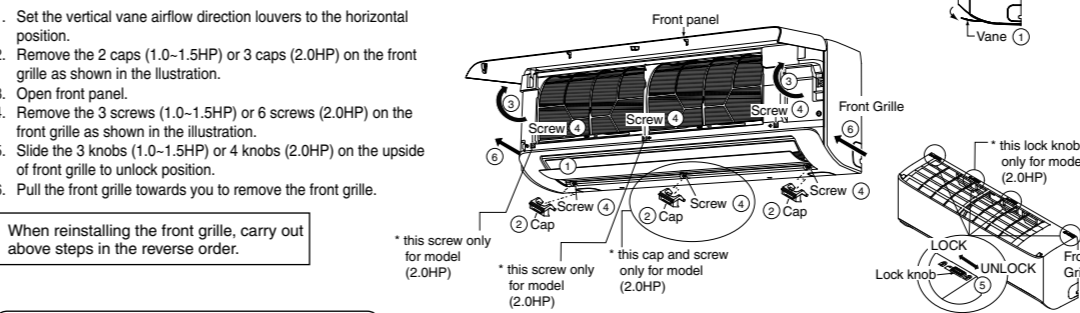

AUTO SWITCH OPERATION

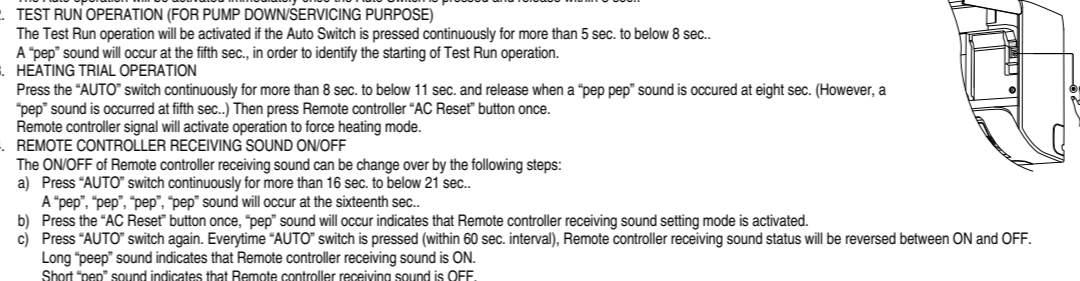

4 AIR TIGHTNESS TEST ON THE REFRIGERATING SYSTEM

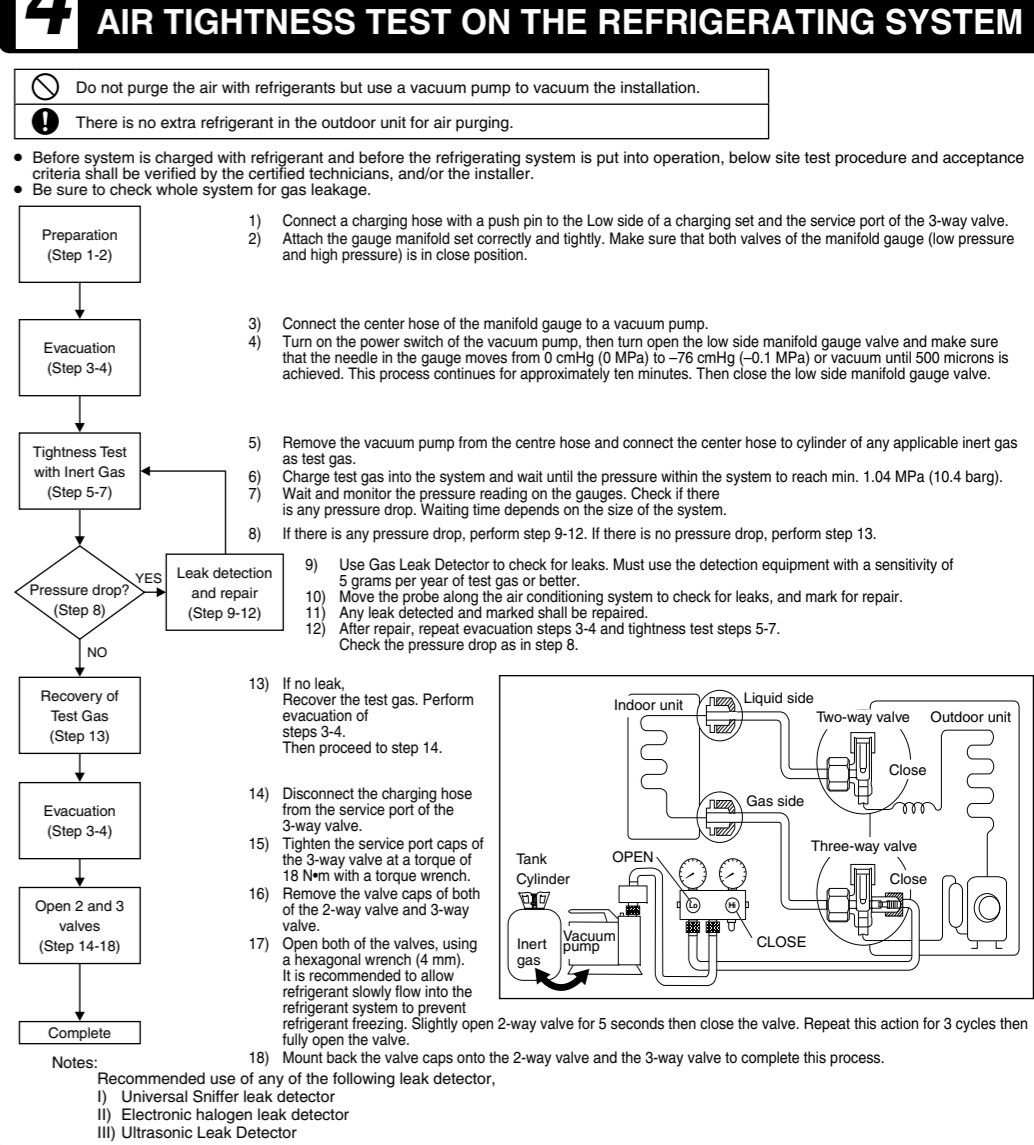

CUTTING AND FLARING THE PIPING

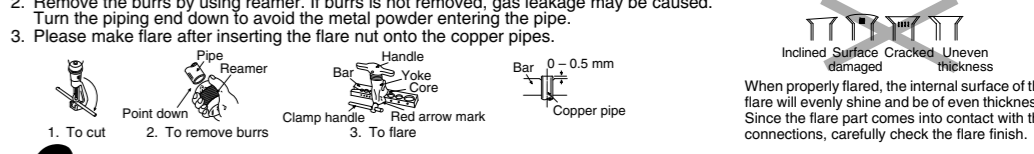

6 PIPING INSULATION

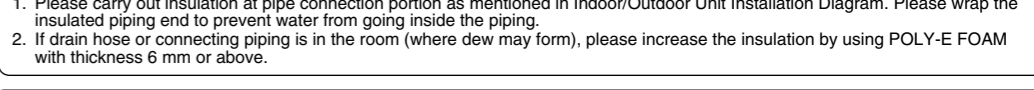

HEATING ONLY OPERATION

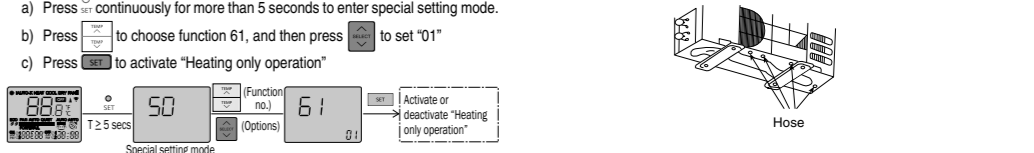

CHECK THE DRAINAGE

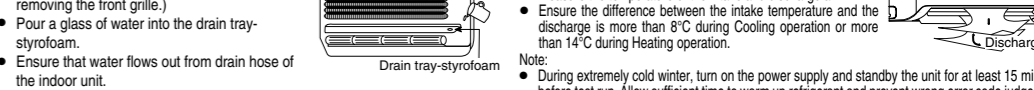

HOW TO REPLACE NETWORK ADAPTER



IN CASE OF REUSING EXISTING REFRIGERANT PIPING

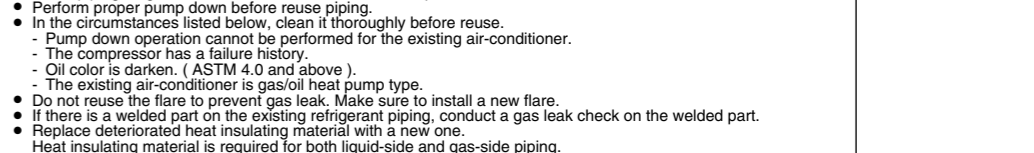

Proper Pump Down Method



CHECK ITEMS

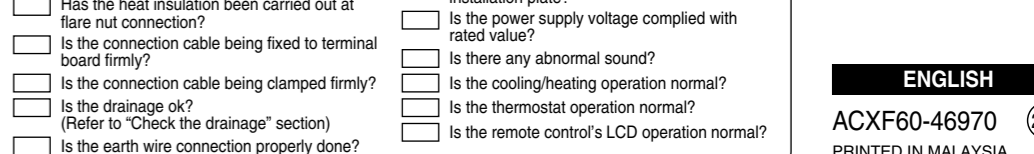

INOMHUSENHET

1 VÄLJ DEN BÄSTA PLATSEN

(Se kapitel "Välj den bästa platsen")

2 FASTSÄTTNING AV INSTALLATIONSPLATTAN

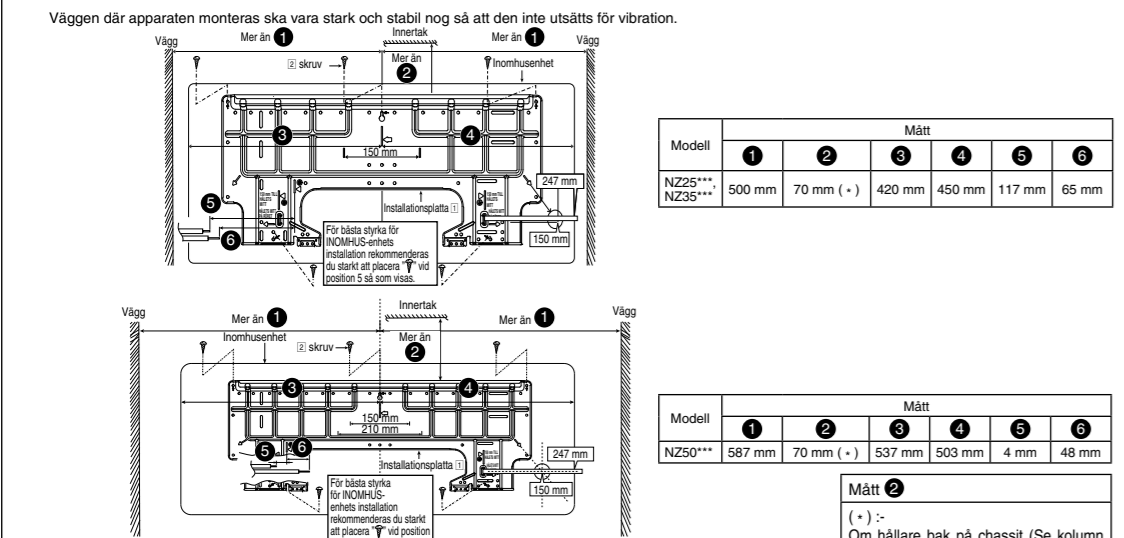

Installationsplåt mitt ska vara min. ① från väggens höger eller vänstra kant. Avståndet mellan installationsplåten änd och taket ska vara minst ②. Från installationsplåttens mitt till enhetens vänstra sida ③. Från installationsplåttens mitt till enhetens högra sida ④. Vid rördragning från vänster ska röranslutningen på vätskesidan placeras ca. ⑤ från denna linje. Vid rördragning från vänster ska röranslutningen på gassidan placeras ca. ⑥ från denna linje. Placera monteringsplattan på väggen med minst fem skruvar. (minst 5 skruvar). (Använd förankringsbultar om apparaten ska fästas vid en betongvägg.) Fäst monteringsplattan horisontellt genom att riktiga in markeringslinjen med ett snöre och ett vattenpass. Använd en kärborrmaskin för att borra ett $\varnothing 70$ mm hål för rörledningen. Ställ in i linje med hjälp av monteringsplåttens högra och vänstra sida. Den förlängda linjens skärningspunkt sammanfaller med hålets mitt. En annan metod är att placera tejp för mätning i det läge som anges i diagrammet ovan. Hålets mitt erhålls genom att mäta avståndet på 150 mm för vänster resp. höger hål (NZ25***, NZ35*** eller 210 mm för vänster hål och 150 mm för höger hål (NZ50***)). Borra hålet för röret antingen till höger eller till vänster. Hålet ska luta lätt mot utomhusidn.

3 BORRA HÅL I VÄGGEN OCH MONTERA EN RÖRMUFF

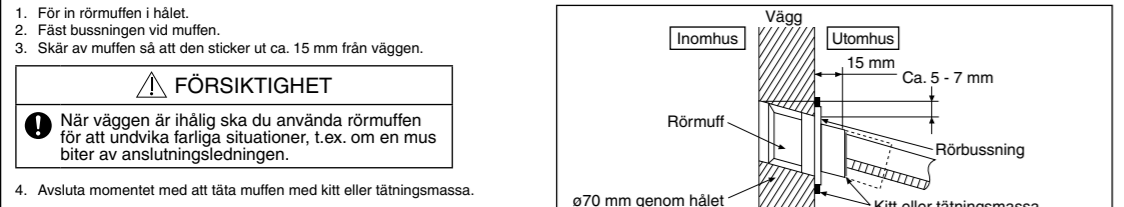

5 ANSLUT ELKABEL TILL INOMHUSENHETEN

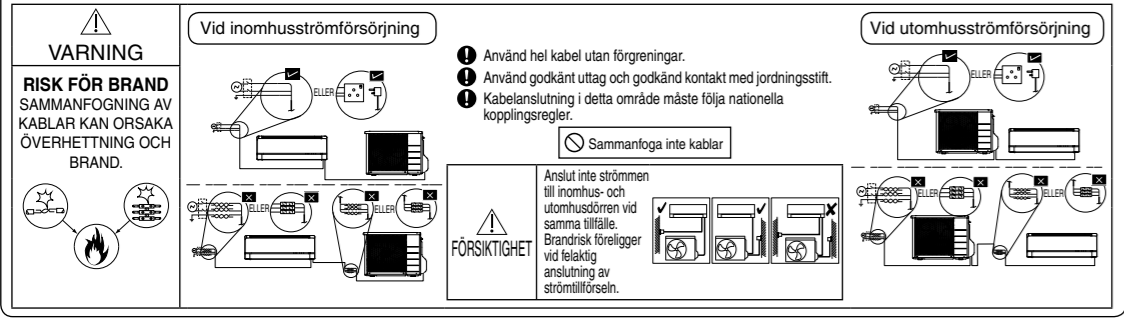
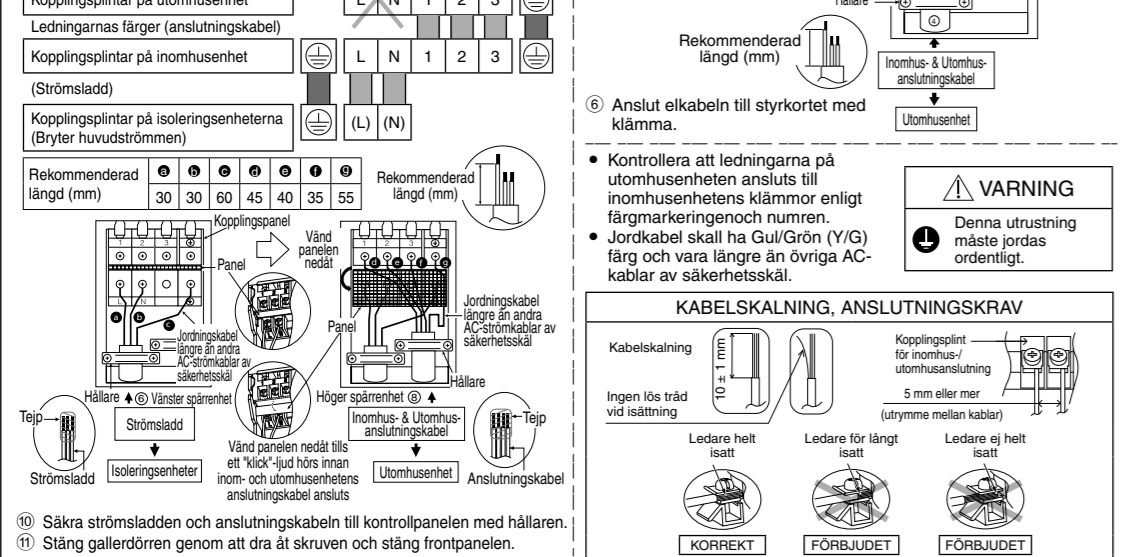
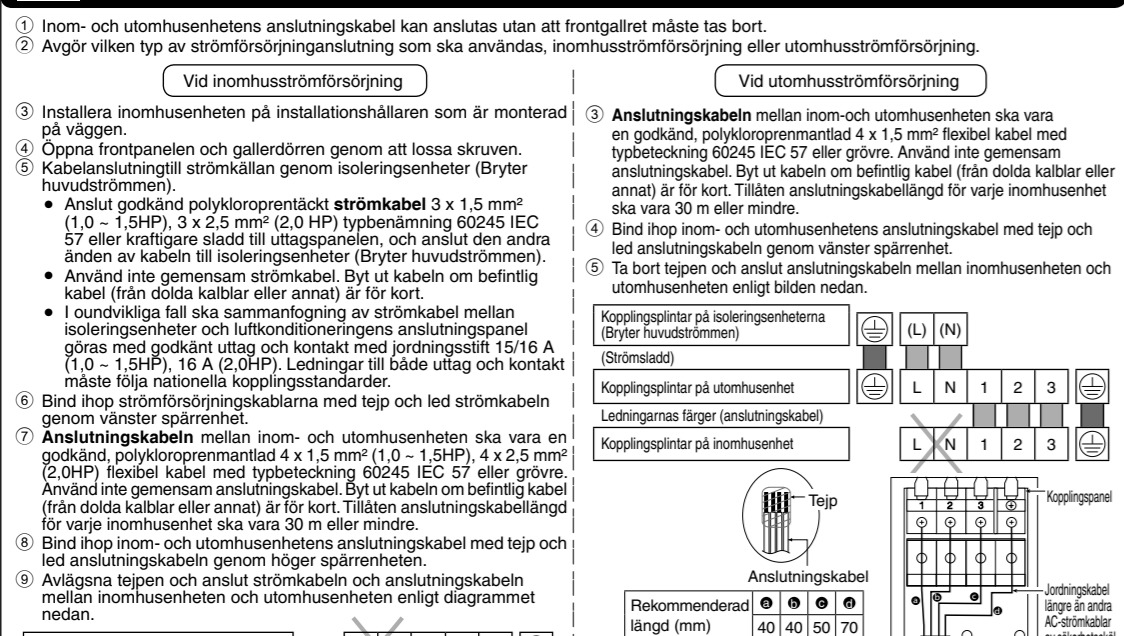

4 INSTALLATION AV INOMHUSENHET

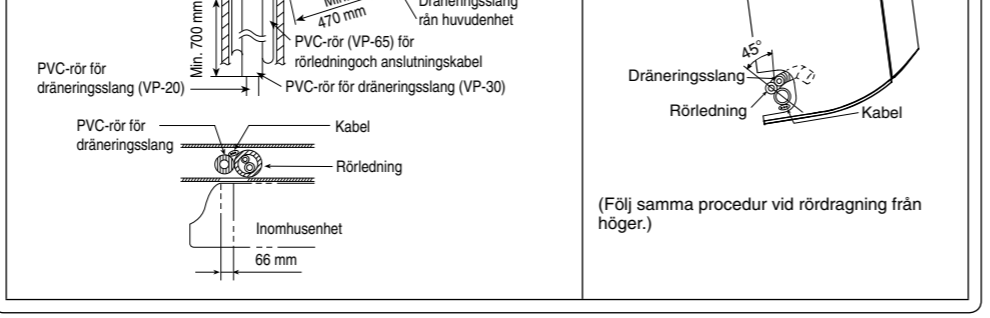
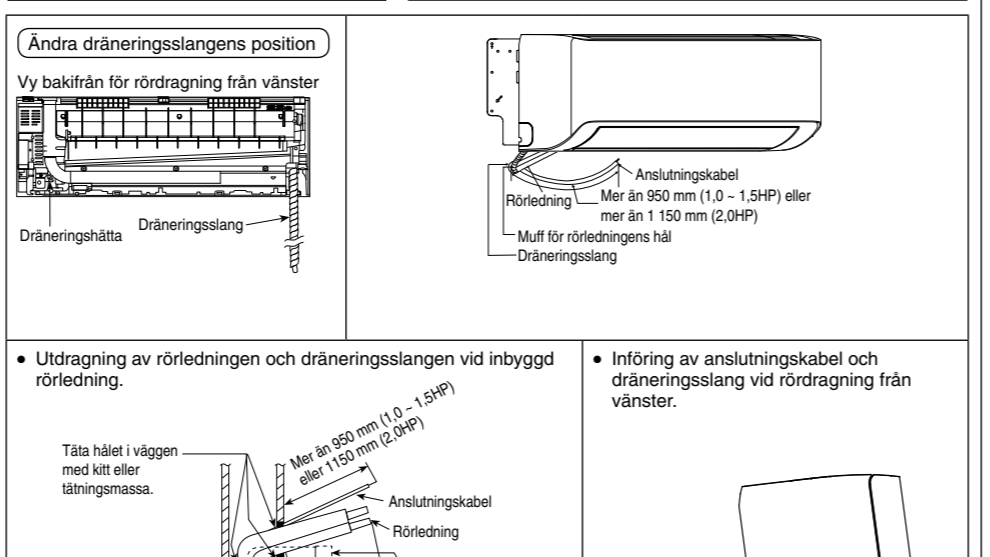
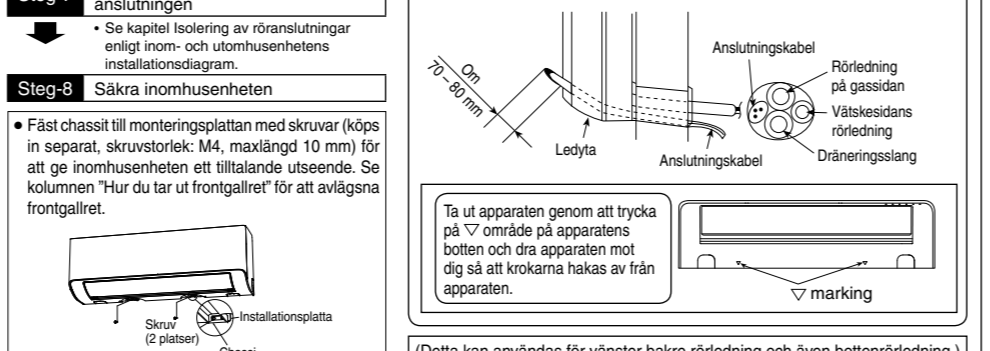
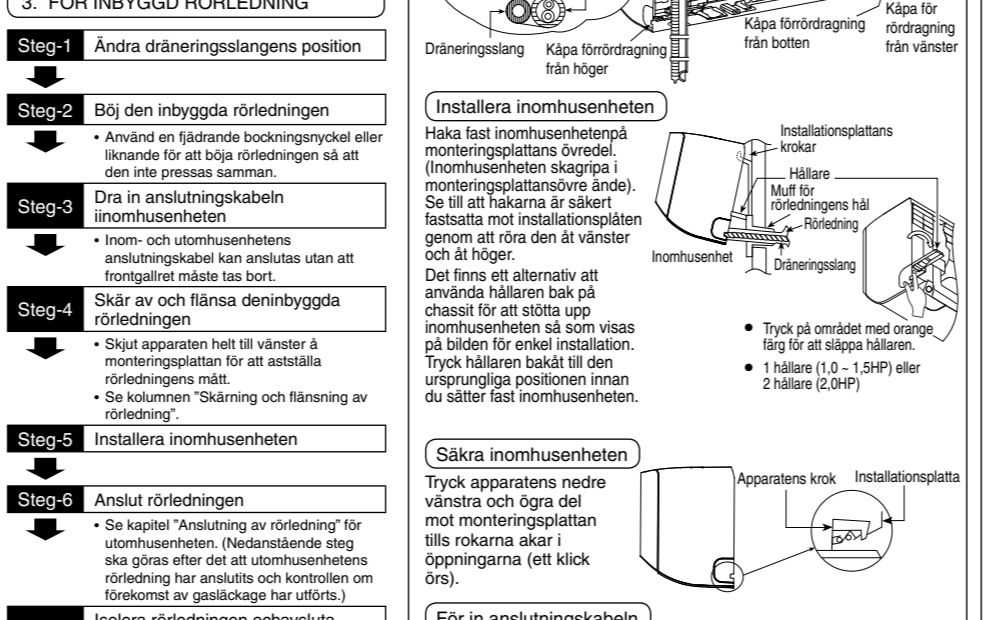
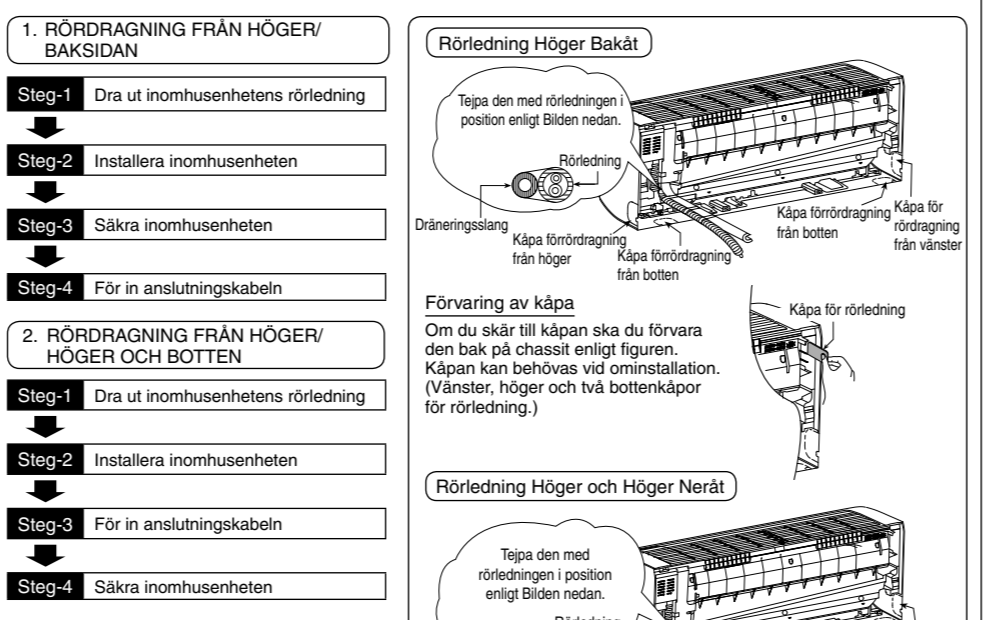
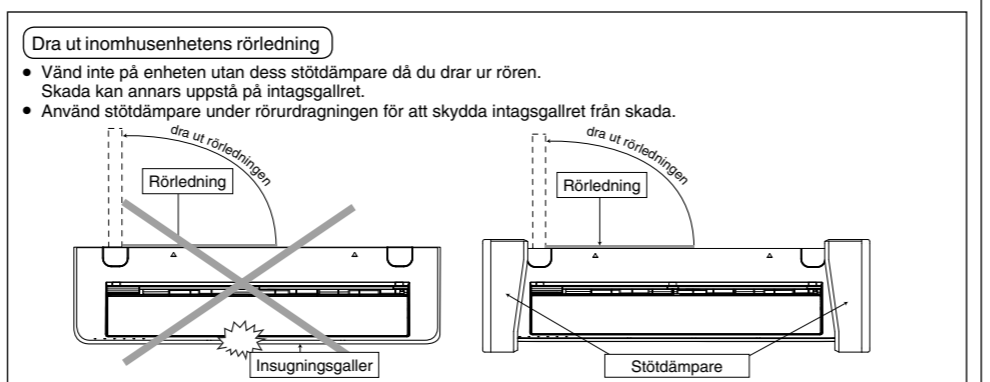

UTOMHUSENHET

1 VÄLJ DEN BÄSTA PLATSEN

(Se kapitel "Välj den bästa platsen")

2 INSTALLERA UTOMHUSENHETEN

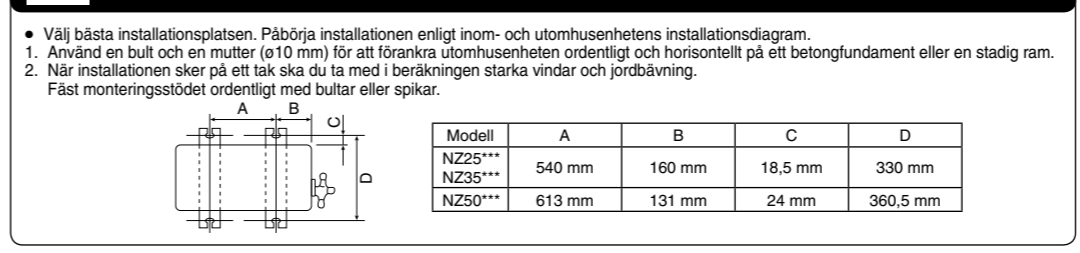

3 ANSLUT RÖRLEDNINGEN

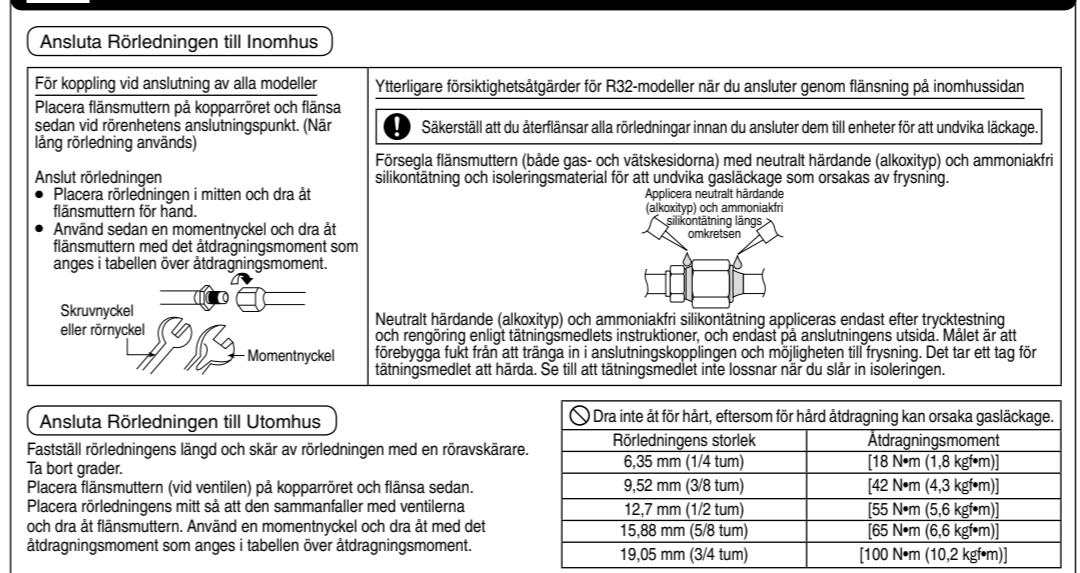

5 ANSLUT ELKABEL TILL UTOMHUSENHETEN

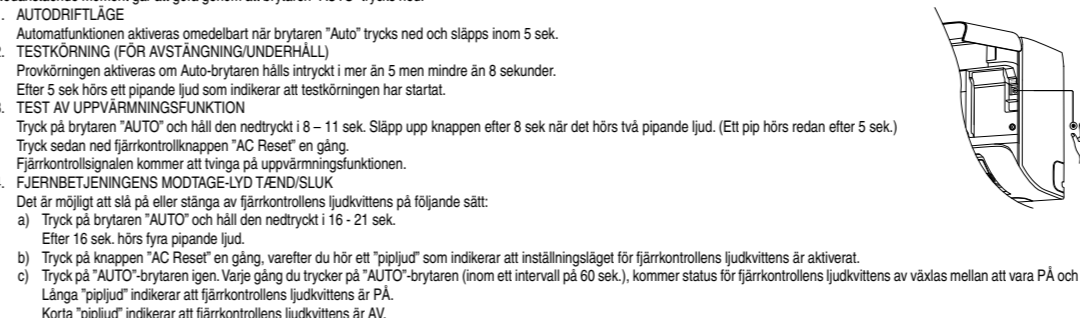
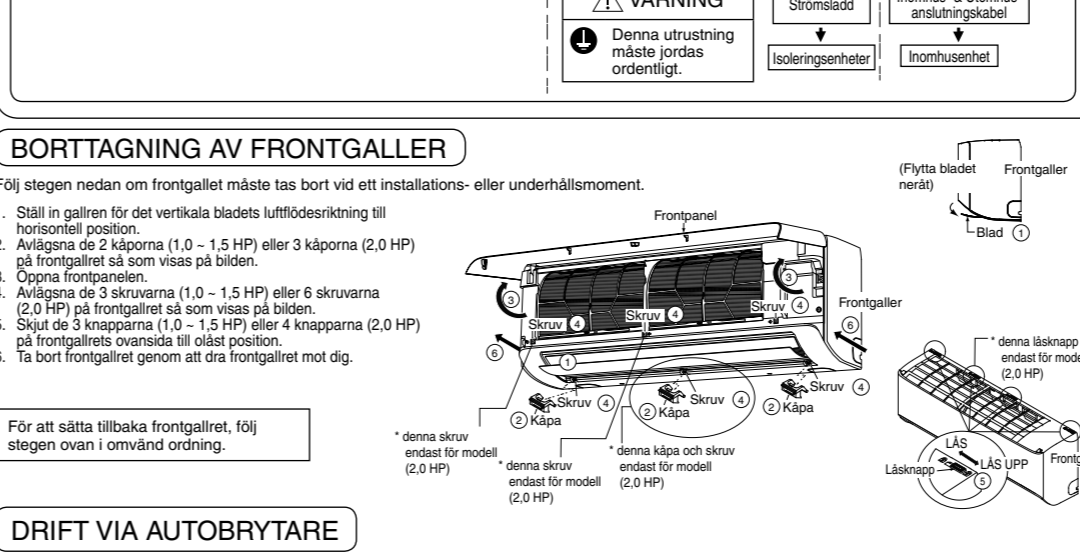
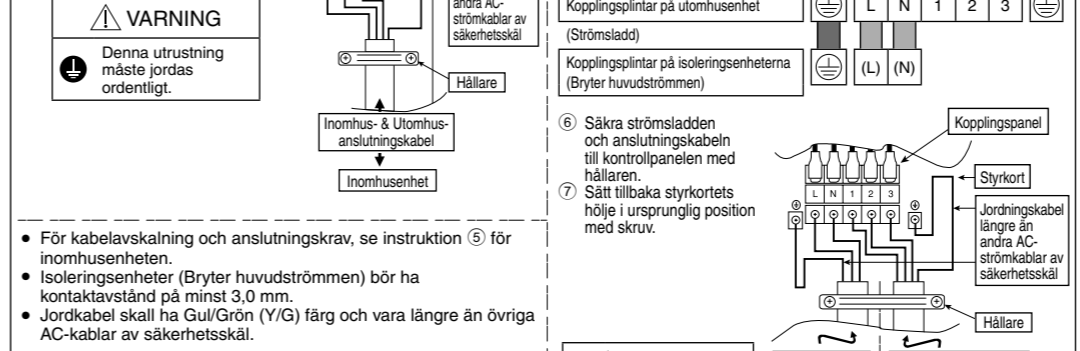
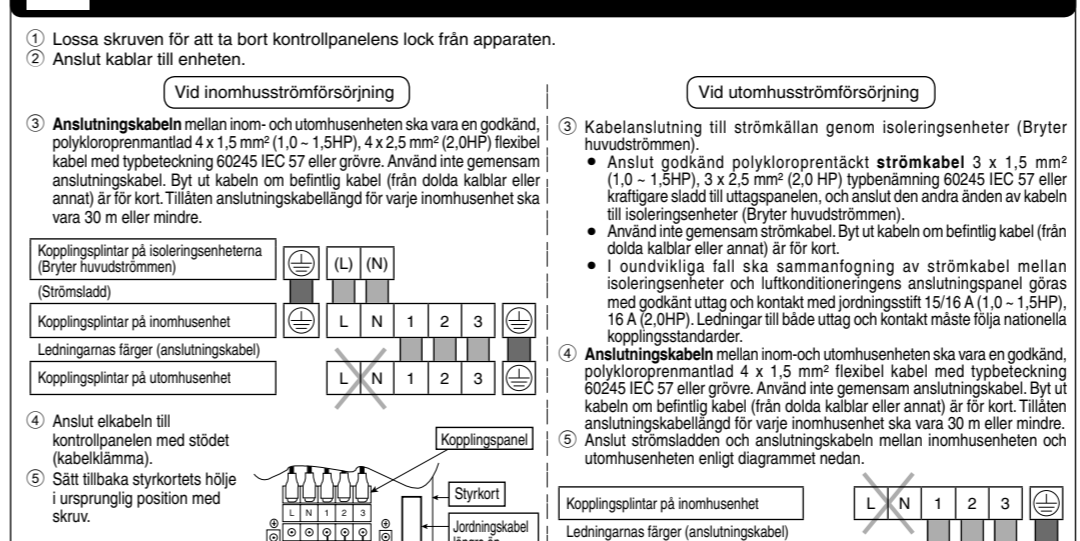

4 LUFTRÄNSELTEST FÖR KYLSKÅPSSYSTEMET

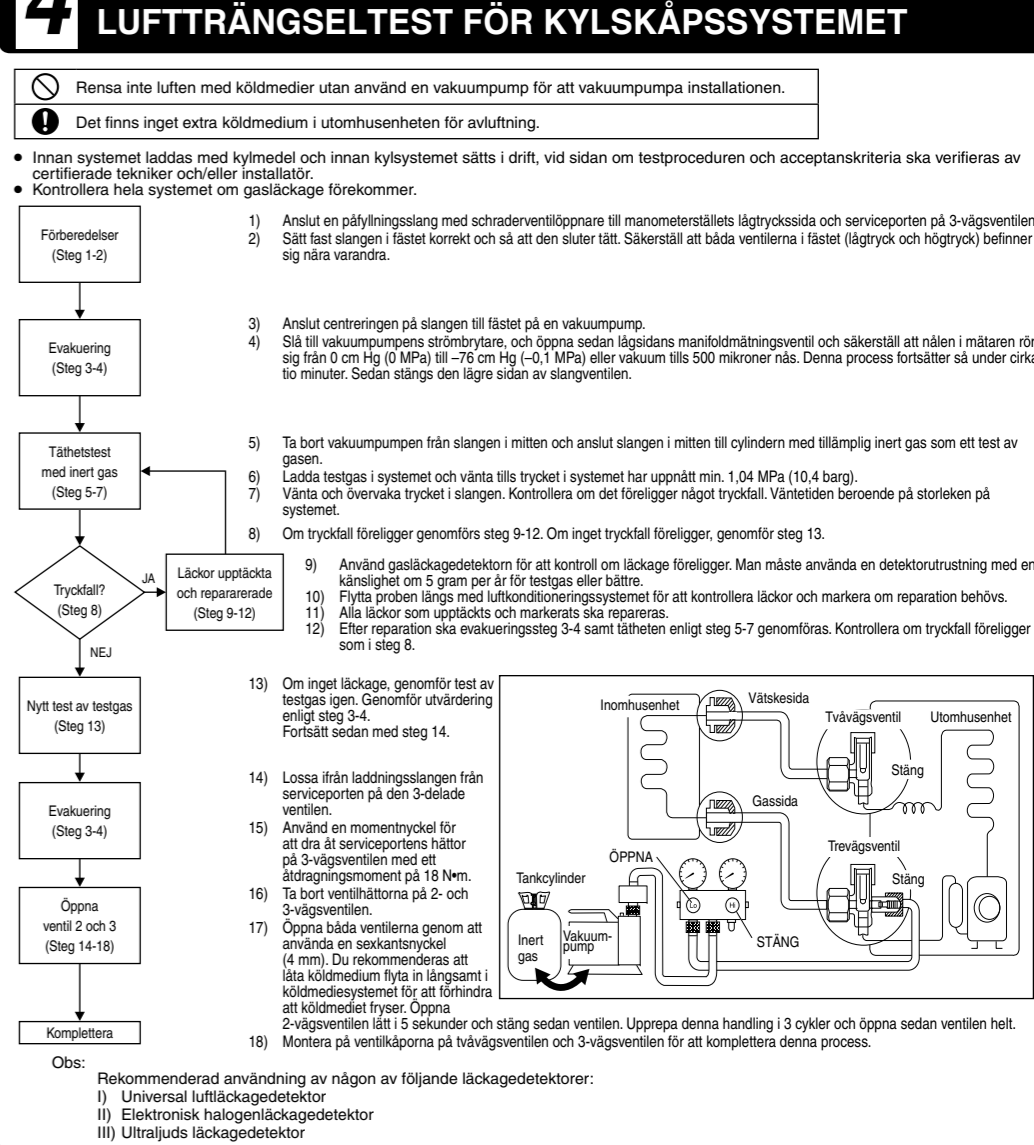

KAPNING OCH FLÄNSNING AV RÖRLEDNING

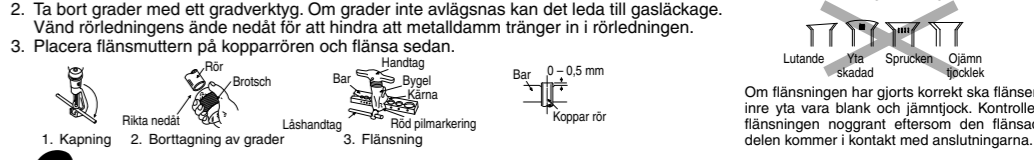

6 RÖRISOLERING

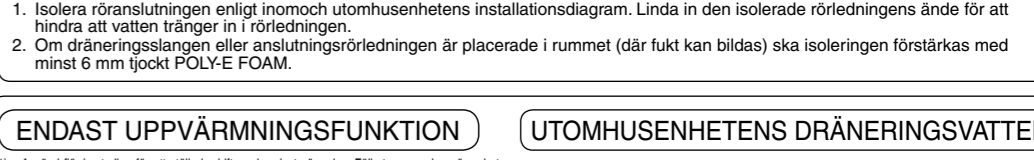

ENDAST UPPVÄRMINGSFUNKTION



KONTROLLERA DRÄNERINGEN

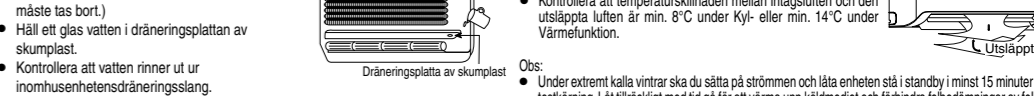

HUR DU BYTER UT NÄTVERKSADAPTERN



FÖR ÅTERANVÄNDNING AV BEFINTLIGA KYLRÖR

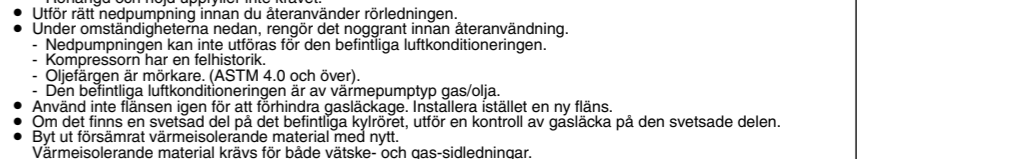

Rätt nedpumpningsmetod

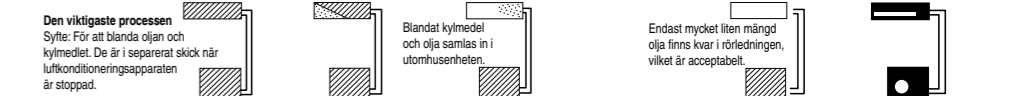

CHECKLISTA

<input type="checkbox"/> Förekommer gasläckage vid flänsstransmans anslutningar?	<input type="checkbox"/> Är inomhusenheten förankrad ordentligt vid installationsplattan?
<input type="checkbox"/> Har flänsstransmans anslutningar vätskesidats?	<input type="checkbox"/> Är manningsspanningen inomnäringsvärdet för kopplingspanelen?
<input type="checkbox"/> Har anslutningskabeln lästs ordentligt vid kopplingspanelen?	<input type="checkbox"/> Hörs konstigt buler?
<input type="checkbox"/> Har anslutningskabeln klämts läst ordentligt?	<input type="checkbox"/> Fungerar kyltingsuppvärmningsfunktionen?
<input type="checkbox"/> Fungerar dräneringen?	<input type="checkbox"/> Fungerar termostaten?
<input type="checkbox"/> (Se kapitel "Kontrollera dräneringen")	<input type="checkbox"/> Fungerar fjärrkontrollens display?
<input type="checkbox"/> Är jordanslutningen korrekt?	

INNENDØRSENHET

1 VELG BESTE PLASSERING

(Les avsnittet "Velg beste plassering")

2 SLIK FESTES INSTALLASJONSPLATEN

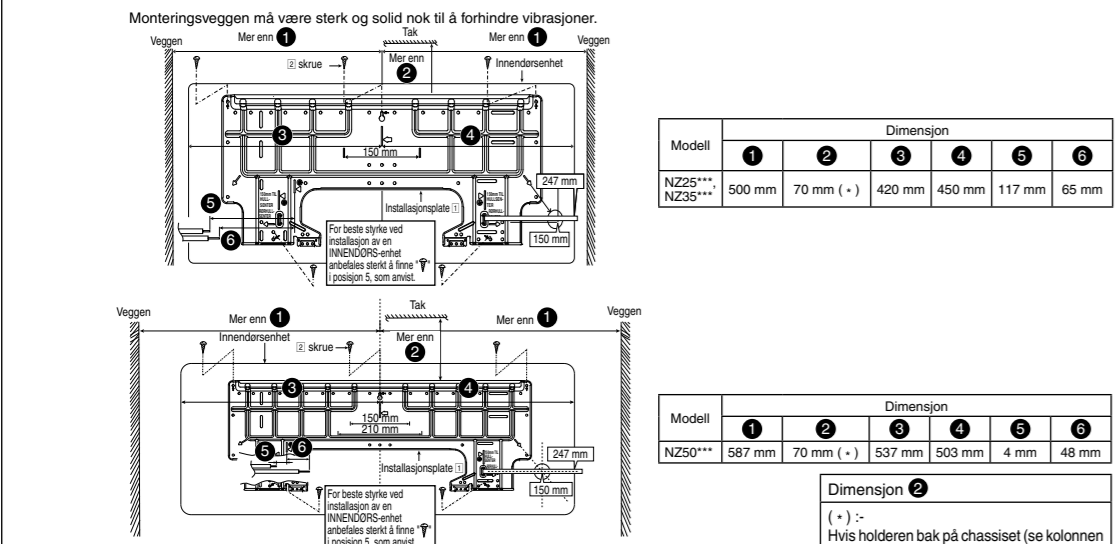

Senter på installasjonsplate bør være mer enn 1) mm til høyre og venstre på veggen. Avstanden fra kanten på installasjonsplaten til taket må være mer enn 2). Fra installasjonsplaten senter til enhetsens venstre side er 3). Fra installasjonsplaten senter til enhetsens høyre side er 4).

For røropplegg til venstre bør rørbøying for væske være omtrent 5) fra dannelsen. For røropplegg til høyre bør rørbøying for gass være omtrent 6) fra dannelsen.

1. Monter installasjonsplaten på veggen med 5 skruer eller mer (minst 5 skruer). (Ved monteringen av enhet på murvegg, bør du vurderer å bruke forankringsbolter.)
2. Monter alltid installasjonsplaten horisontalt ved å justere markeringslinjen med tråden og bruke en nivåmer.
3. For røropplegg til venstre bør rørbøying for væske være omtrent 5) fra dannelsen. For røropplegg til høyre bør rørbøying for gass være omtrent 6) fra dannelsen.
4. Monter installasjonsplaten på veggen med 5 skruer eller mer (minst 5 skruer).
5. Monter alltid installasjonsplaten horisontalt ved å justere markeringslinjen med tråden og bruke en nivåmer.
6. For røropplegg til høyre bør rørbøying for væske være omtrent 5) fra dannelsen. For røropplegg til venstre bør rørbøying for gass være omtrent 6) fra dannelsen.

1. Monter installasjonsplaten på veggen med 5 skruer eller mer (minst 5 skruer). (Ved monteringen av enhet på murvegg, bør du vurderer å bruke forankringsbolter.)

2. Drill hull i rørpipen med en 670 mm hullkjernefrid.

3. Still på linje med bruk av installasjonsplaten venstre og høyre side. Krysspunktet til den forlengede linjen er midt på hullet. Du kan også bruke målebånd og legge det i posisjonen vist på diagrammet ovenfor. Midten på hullet finner du ved å måle 150 mm fra henholdsvis venstre og høyre hull (NZ25***, NZ35***) eller 210 mm for venstre hull og 150 mm for høyre hull (NZ50***).

4. Bør rørhullet enten til høyre eller venstre, og hullet bør være litt skråslipt mot utdørs siden.

3 DRILL HULL I VEGGEN OG INSTALLER EN RØRMUFFE

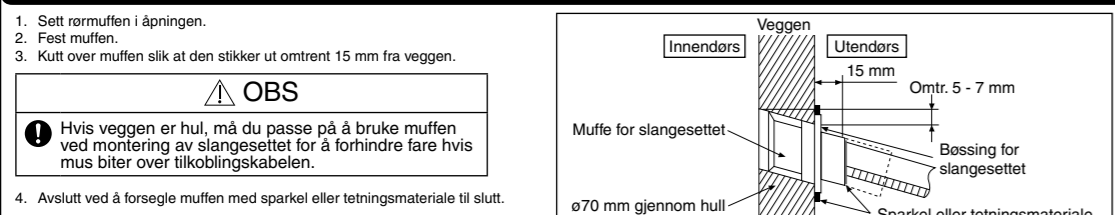

5 TILKOBLING AV KABELN TIL INNENDØRSENHETEN

1. Sett rørmuffen i åpningen.
2. Fest muffen.
3. Kutt over muffen slik at den stikker ut omtrent 15 mm fra veggen.

OBS

1. Hvis veggen er hul, må du passe på å bruke muffen ved monteringen av slangesettet for å forhindre fare hvis mus biter over tilkoblingskabelen.

4. Avslutt ved å forsøke muffen med spærkel eller tetningsmateriale til slutt.

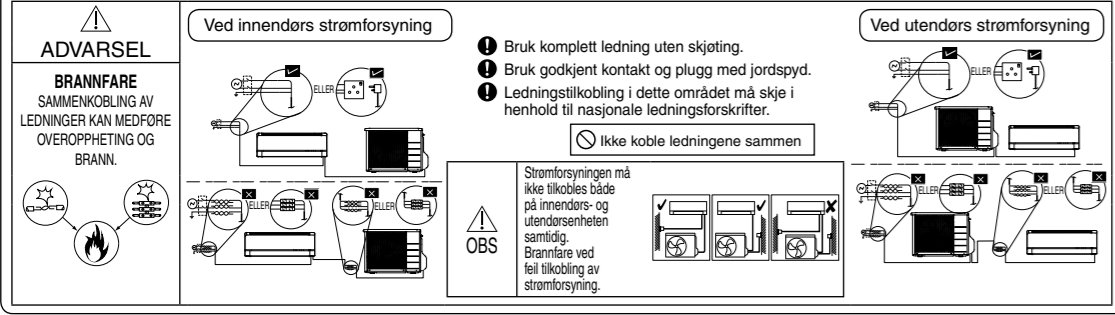
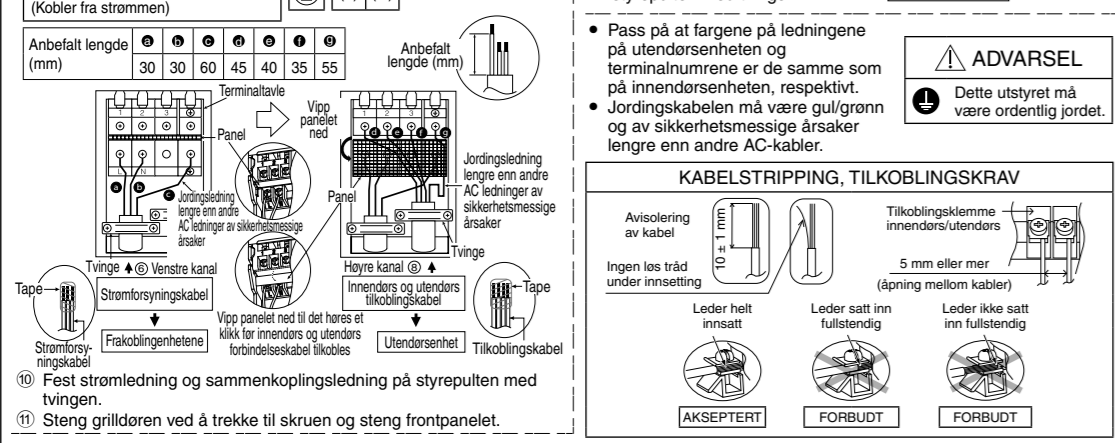
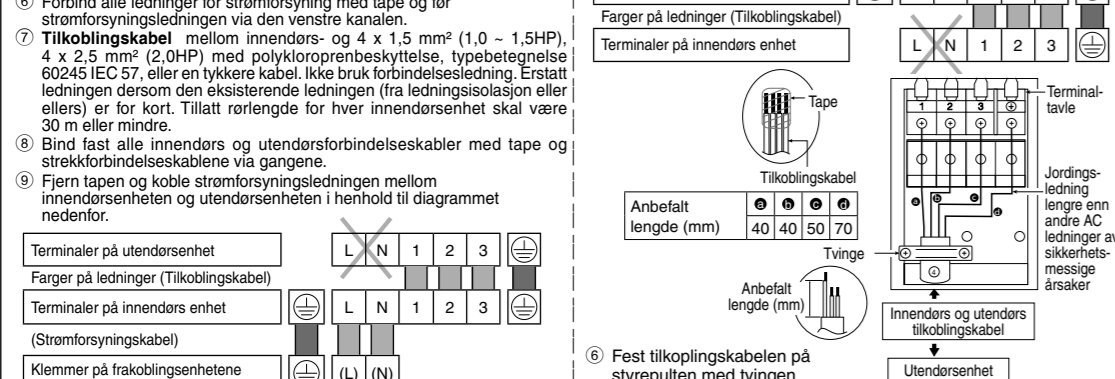

ADVARSEL

BRANNFARE SAMMENKOBLING AV LEIDNINGER KAN MEDFØRE OVEROPPHETING OG BRANN.

4 INSTALLASJON AV INNENDØRSENHET

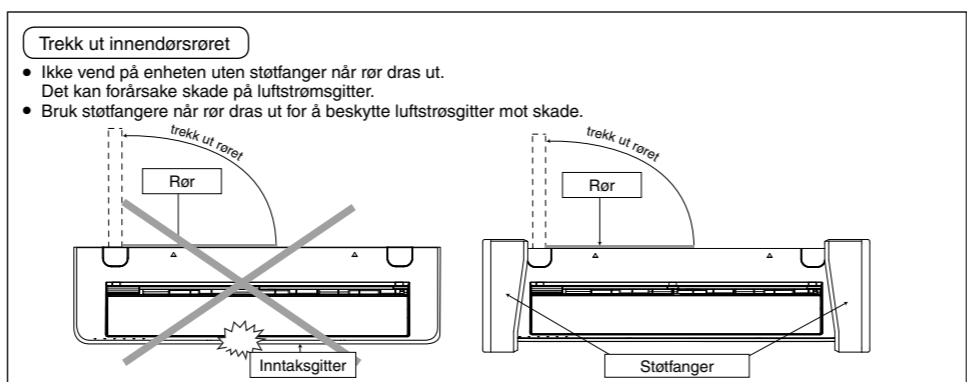

1. FOR RØR BAK TIL HØYRE
2. FOR HØYRE OG NEDRE HØYRE RØR
3. FOR INNEBYGD RØR

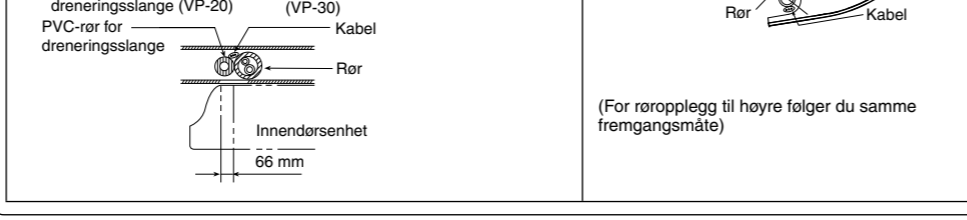
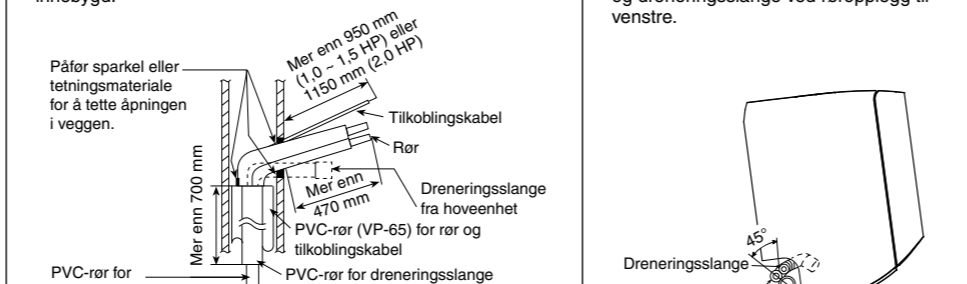
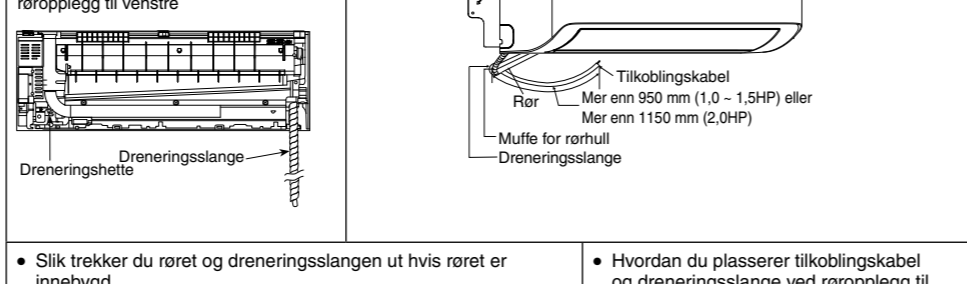
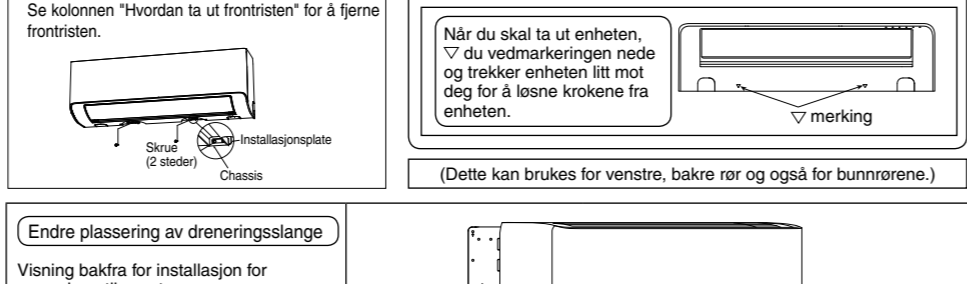
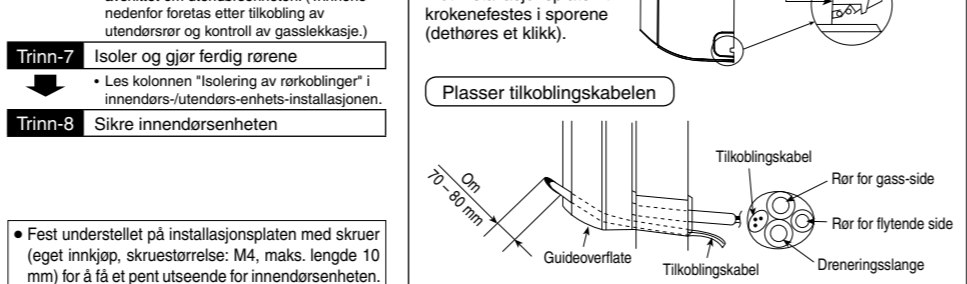
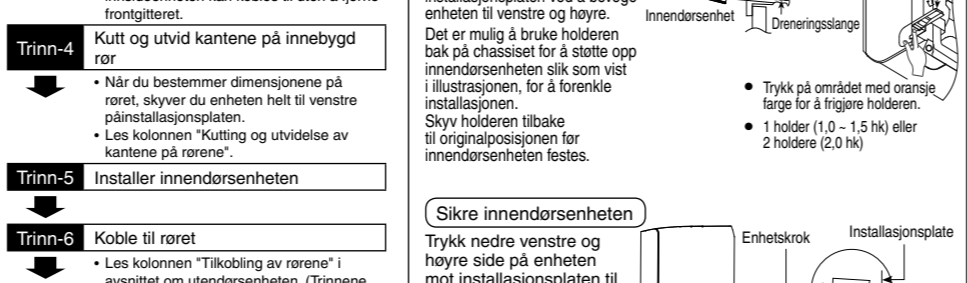
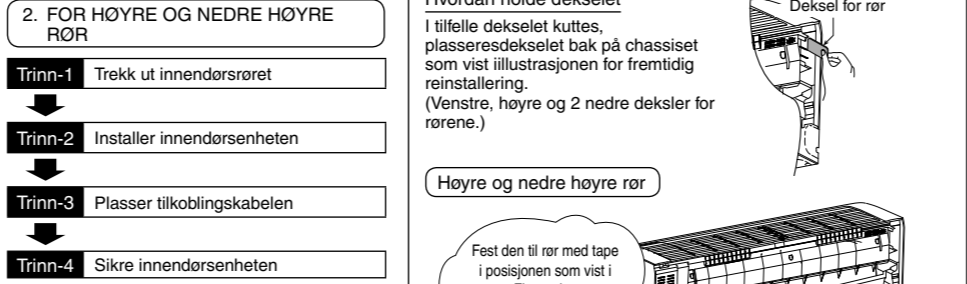

ADVARSEL

BRANNFARE SAMMENKOBLING AV LEIDNINGER KAN MEDFØRE OVEROPPHETING OG BRANN.

UTENDØRSENHET

1 VELG BESTE PLASSERING

(Les avsnittet "Velg beste plassering")

2 INSTALLER UTENDØRSENHETEN

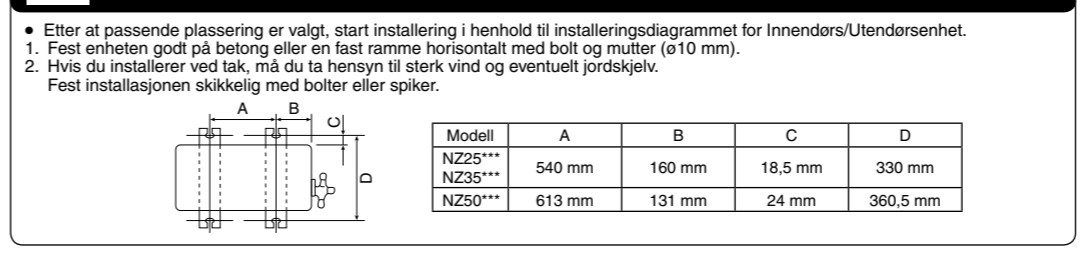

3 KOBLE TIL RØRET

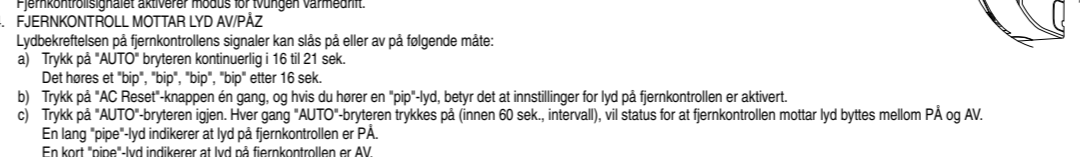
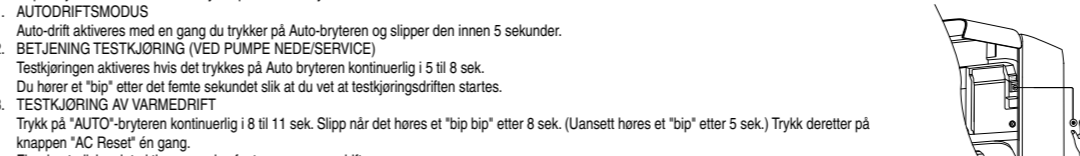
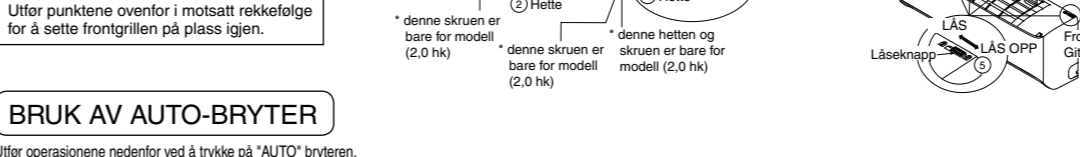
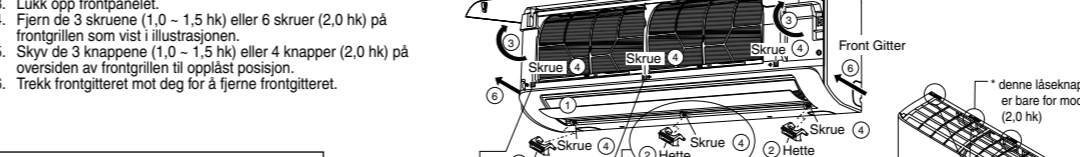
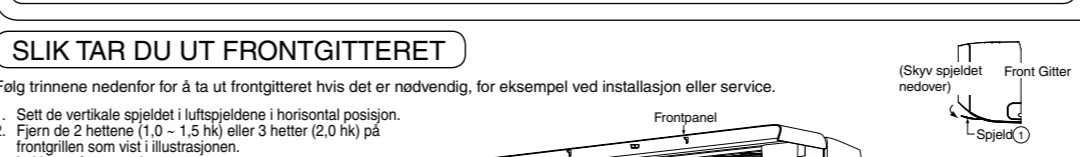
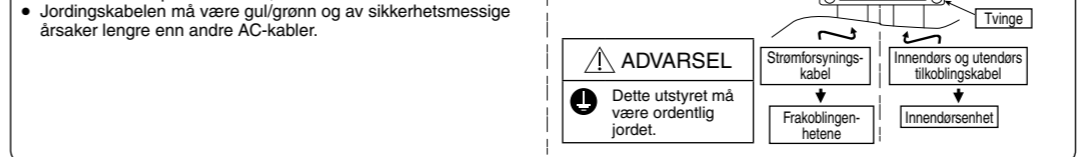
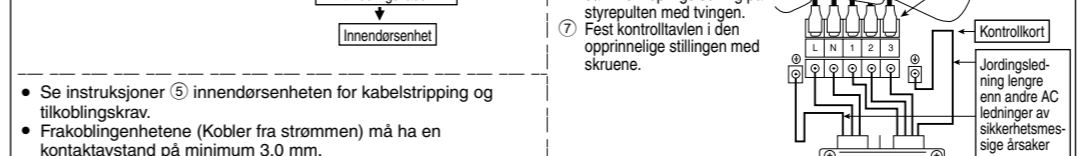
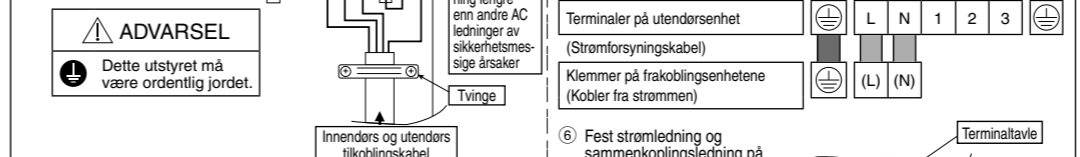
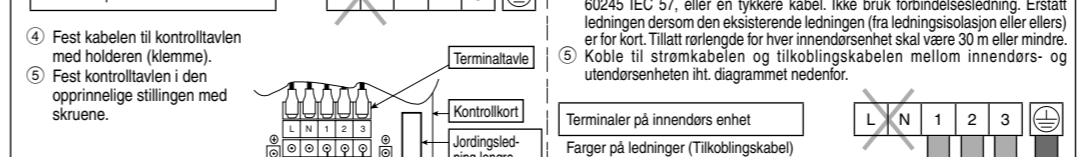
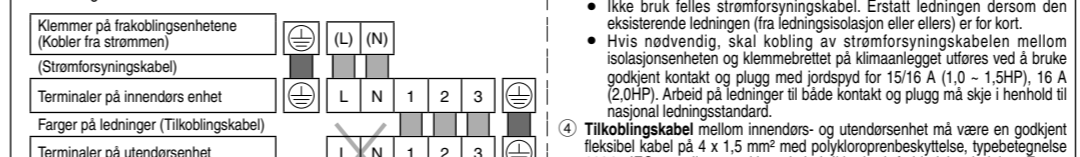
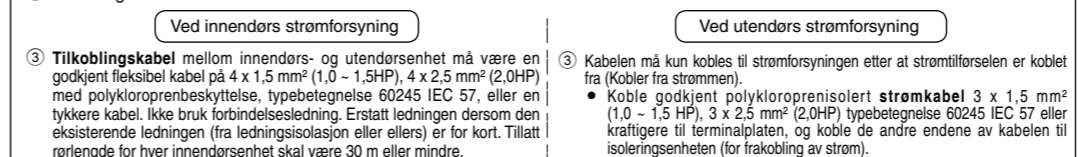
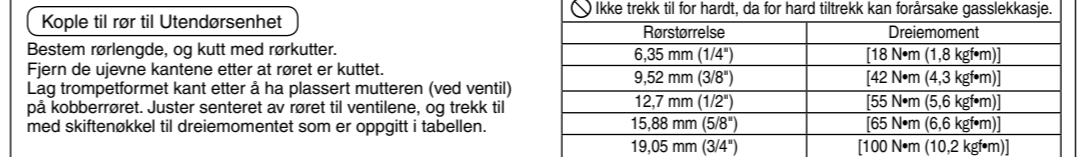
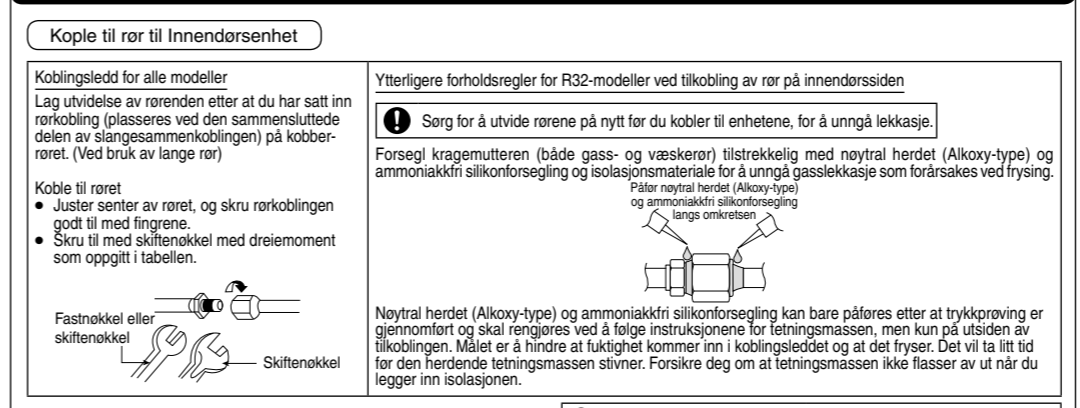

ADVARSEL

BRANNFARE SAMMENKOBLING AV LEIDNINGER KAN MEDFØRE OVEROPPHETING OG BRANN.

LUFTMETODEN ER FORBUDT FOR R32-SYSTEM

4 LUFTTETTHETSTEST PÅ KJØLESYSTEM

Ikke tom luften med kjølemiddel, men bruk en vakuumpumpe for å tømme installasjonen.

Det er ikke noe ekstra kjølemiddel i utendørsenheten for tørring av luft.

For systemet lades med kjølemiddel, og for kjølesystemet settes i drift, skal anleggstestprosedyren nedenfor og akseptkriterier være bekreftet av sertifiserte teknikere, og/eller installatører.

Pass på å kontrollere hele systemet for gasslekkasje.

- 1) Forbind en ladeslange med en skyvepinne til nedre side av ladesett og serviceporten på 3-veisventilen.
- 2) Fest manifoldmåler-sættet riktig og tett. Sørg for at begge ventiler i manifoldmåleren (lav trykk og høy trykk) er i lukket posisjon.

- 3) Koble senterlansen på manifoldmåleren til en vakuumpumpe.
- 4) Slå på strømbryteren på vakuumpumpen, åpne deretter manifoldmåler-ventilen på nedsiden og sørg for at nålen på måleren beveger seg fra 0 cmHg (0 MPa) til -76 cmHg (-1,0 MPa) eller til vakuum på 500 mikron er oppnådd. Denne prosessen fortsetter i omtrent 10 minutter. Steng deretter manifoldmåler-ventilen på nedsiden.

- 5) Fjern vakuumpumpen fra senterlansen og koble senterlansen til sylindren med en passende edelgass som testgass.
- 6) Før testgass inn i systemet og vent til trykket i systemet når minst 1,04 MPa (10,4 barG).
- 7) Vent og overvåk trykkavlesningen på måleren. Kontroller om det er noe trykkfall. Ventildelen avlenger av størrelsen på systemet.
- 8) Hvis det er noe trykkfall, utføres trinn 9-12. Hvis det ikke er noe trykkfall, utføres trinn 13.

- 9) Bruk gasslekkasjeteleforer for å kontrollere for lekkasjer. Det må brukes deteksjonsutstyr med en følsomhet på 5 gram per år for testgass eller bedre.
- 10) Fyll sonden langs klimaanleggssettet for å se etter lekkasjer, og merk av for reparasjon.
- 11) Etter lekkasje som er detektert og merket, skal reparasjon utføres.
- 12) Etter reparasjon gjenntas evaluering trinn 3-4 og tetthetstest trinn 5-7. Kontroller trykkfallet som i trinn 8.

- 13) Hvis det ikke er noen lekkasje, skal testgassen gjenntas. Utfør evaluering i trinn 3-4.
- 14) Koble fra ladeslangen fra serviceporten på 3-veisventilen.
- 15) Stram til hettene på serviceporten på 3-veisventilen med et dreiemoment på 18 Nm med en skiftenøkkel.
- 16) Fjern ventilhettene på både 2-veisventilen og 3-veisventilen.
- 17) Åpne begge ventiler med en sekskantnøkkel (4 mm). Det anbefales å koble kjølemiddeltype langsomt inn i kjølesystemet for å hindre at kjølemiddel fryser. Åpne 2-veisventilen i 15 sekunder og steng deretter ventilen. Gjenta denne handlingen 3 ganger og åpne deretter ventilen helt.
- 18) Monter ventilhettene tilbake på 2-veisventilen og 3-veisventilen for å fullføre denne prosessen.

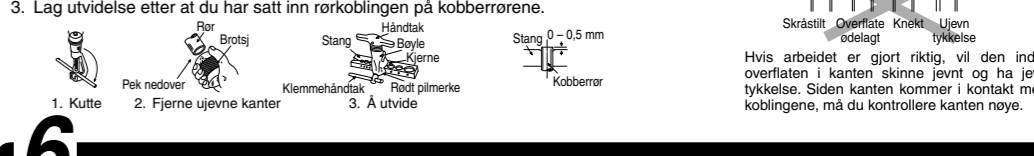

INDENDØRS ENHED

1 VÆLG DEN BEDSTE PLACERING

(Se sektionen "Vælg den bedste placering")

2 SÅDAN SÆTTER DU INSTALLATIONSPLADEN OP

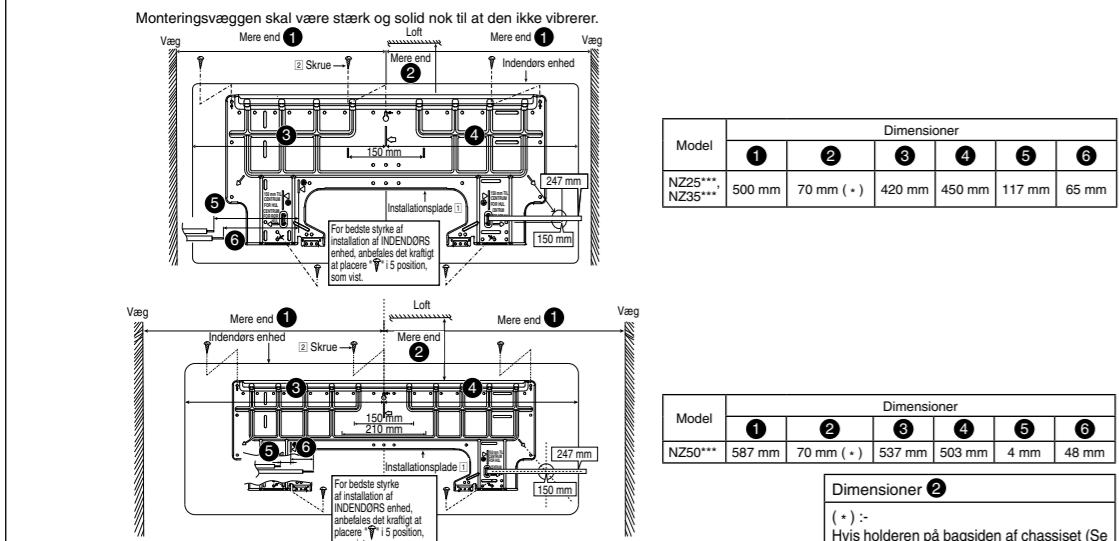

- Installationspladens centrum bør være midtst (1) mm til højre og venstre for væggene. Afstanden fra installationspladens kant til loftet bør være mere end (2). Fra installationspladens midte til enhedens venstre side er (3). Fra installationspladens midte til enhedens højre side er (4).
- For rørsystem i venstre side bør der være (5) fra denne linie til væskørøret. For rørsystem i venstre side bør der være omtrent (6) fra denne linie til gasrøret.
- Monter installationspladen på væggen ved brug af 5 skruer eller mere (mindst 5 skruer). (Hvis du monterer enheden på en betovæg bør du overveje at bruge forankringsbolte.)
 - Bor et hul til rørsystemet med et 0,70 mm hulporrørborer.
 - Lav en linie ud fra installationspladens højre og venstre side.
 - Endepunktet for den forlængede linie er hullens centrum.
 - En anden metode er at sætte målebåndet op som vist i diagrammet ovenfor.
 - Hullets centrum findes ved at måle distancerne respektive 150 mm for det venstre og højre hul (NZ25***, NZ35***) eller 210 mm for venstre og 150 mm for højre (NZ50***).
 - Bor rørføringshullet på enten højre eller venstre side, og huller skal til skrånende til den udendørs side.

3 SÅDAN BORER DU ET HUL I VÆGGEN OG MONTERER EN KRAVE TIL RØRSYSTEMET

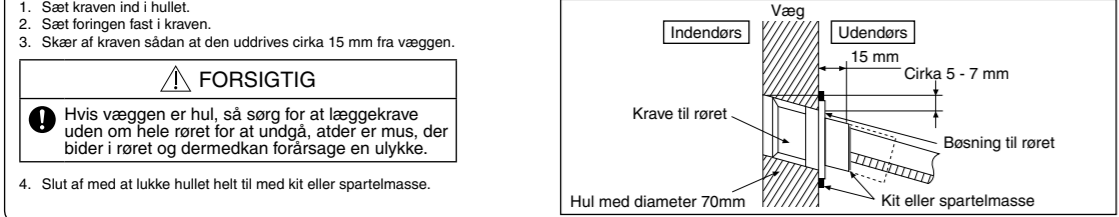

5 TILSLUTNING AF KABLET TIL DEN INDENDØRS ENHED

- Det indendørs- og udendørsforbindelseskabel kan forbindes uden at fronttristen flyttes.
- Beslut dig for, hvilken type strømforsyningstilslutning, der skal anvendes: indendørs strømforsyning eller udendørs strømforsyning.

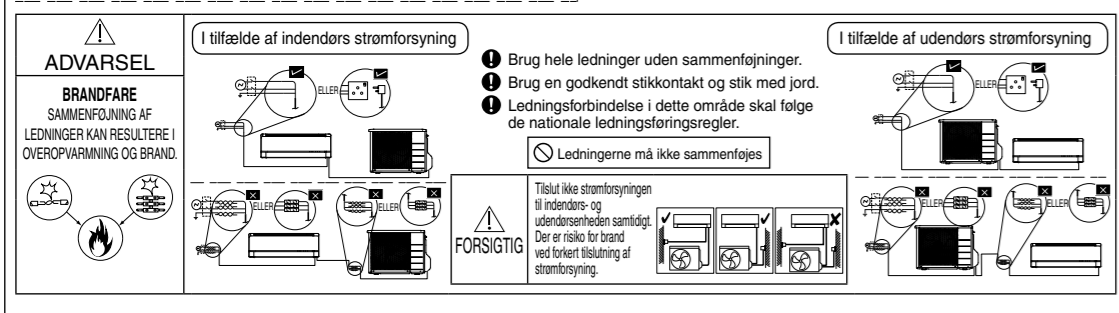
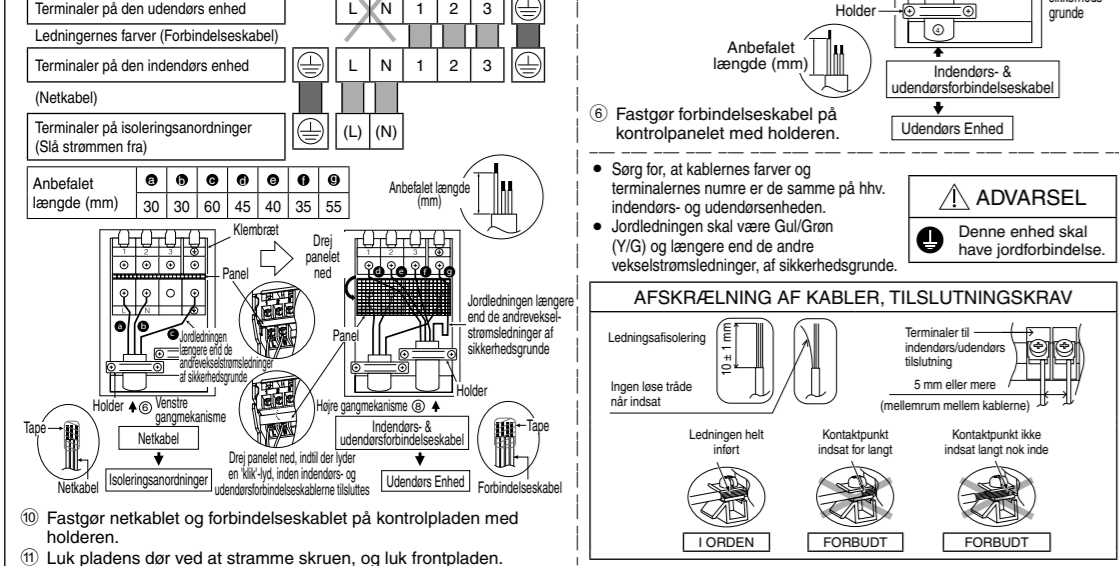

4 INSTALLATION AF DEN INDENDØRS ENHED

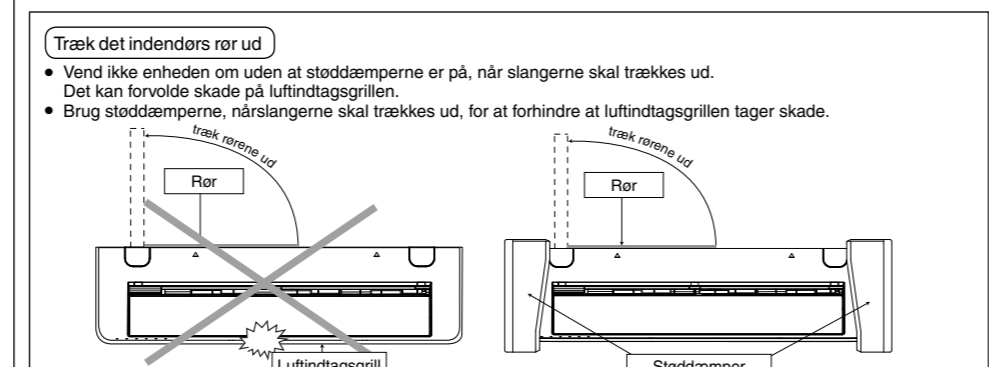

1. FOR DET BAGERSTE HØJRE RØR

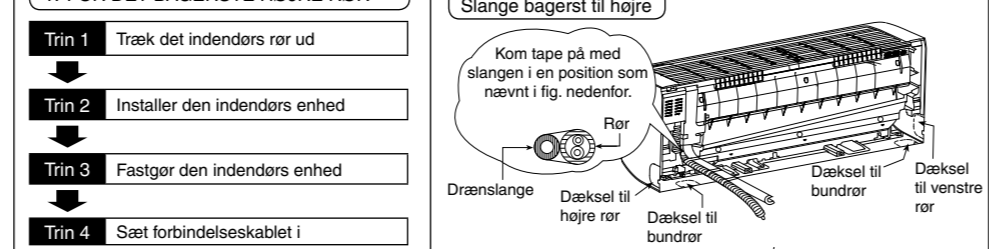

2. FOR DET HØJRE OG BAGERSTE HØJRE RØR

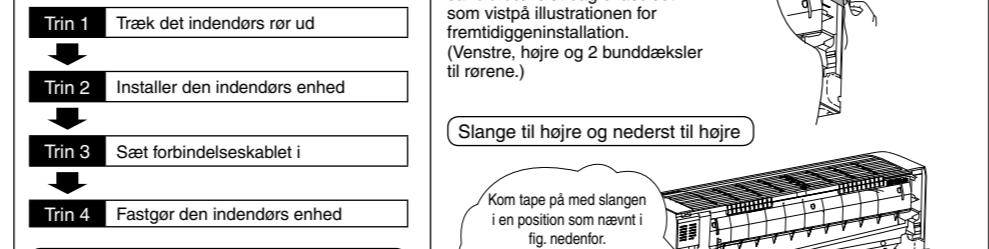

3. FOR DET INDKAPSELEDE RØR



4. FOR DET INDKAPSELEDE RØR

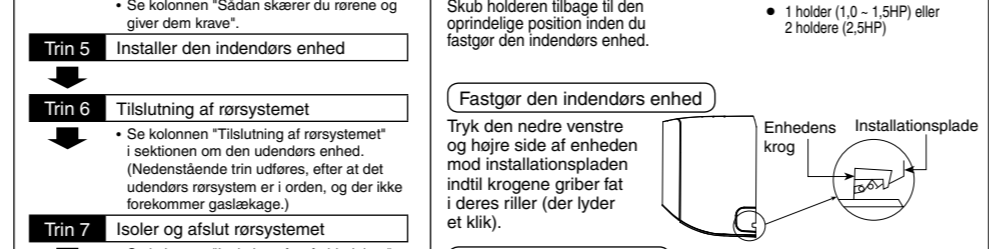

5. FOR DET INDKAPSELEDE RØR

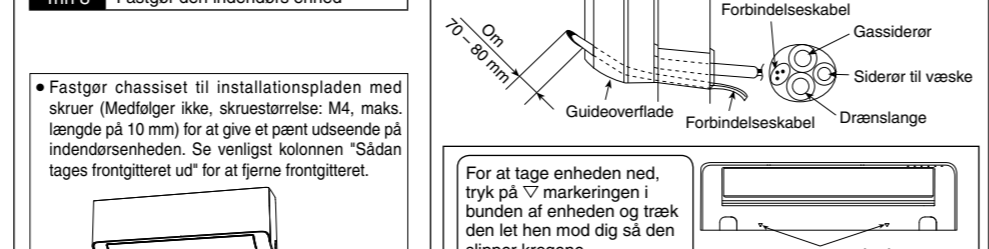

6. FOR DET INDKAPSELEDE RØR

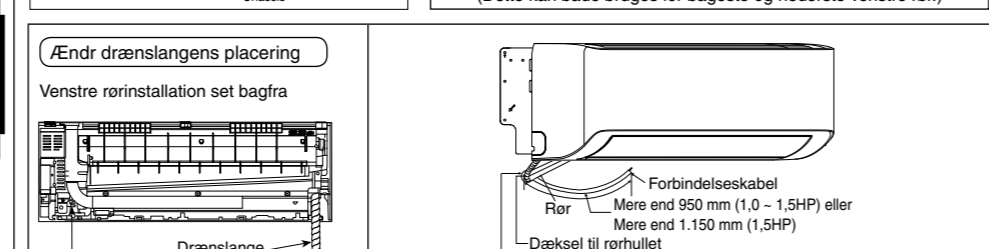

7. FOR DET INDKAPSELEDE RØR

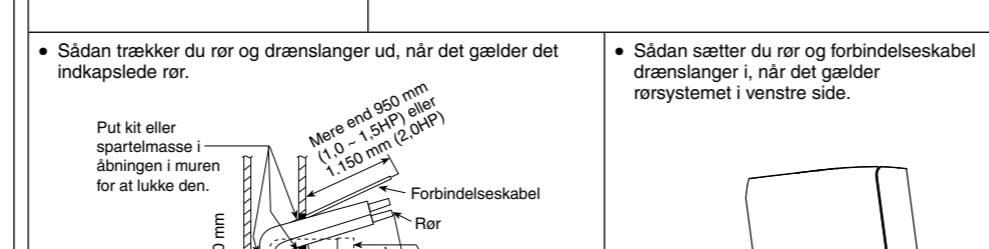

8. FOR DET INDKAPSELEDE RØR

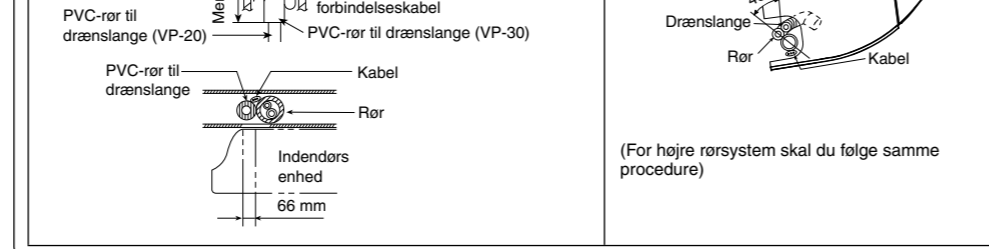

UDENDØRS ENHED

1 VÆLG DEN BEDSTE PLACERING

(Se sektionen "Vælg den bedste placering")

2 INSTALLER DEN UDENDØRS ENHED

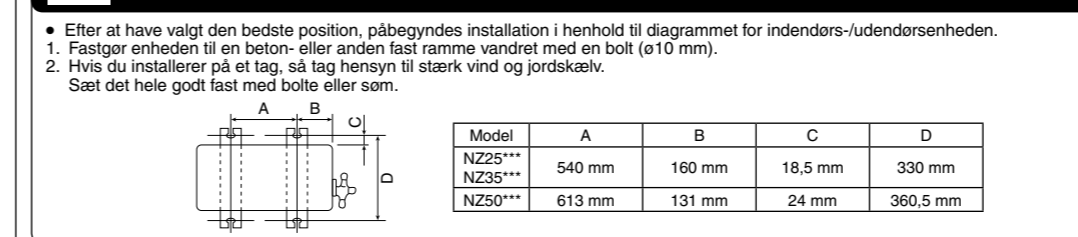

3 TILSLUTNING AF RØRSYSTEMET

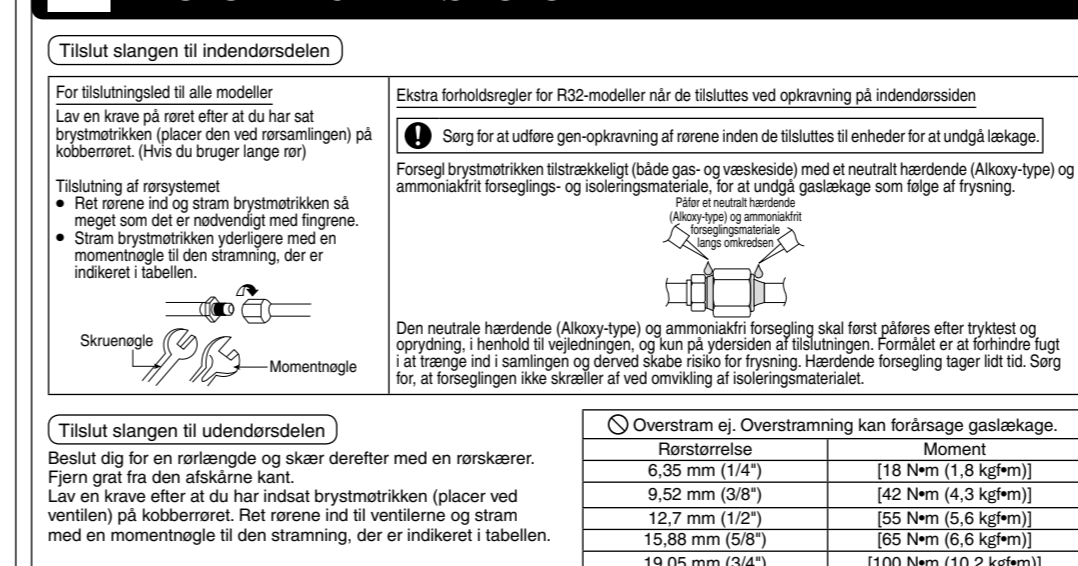

5 TILSLUTNING AF KABLET TIL DEN UDENDØRS ENHED

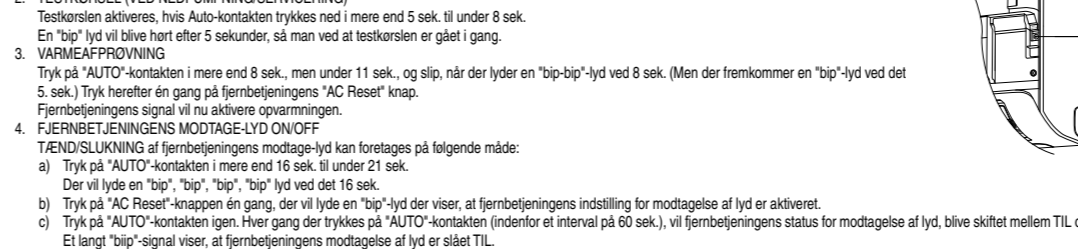
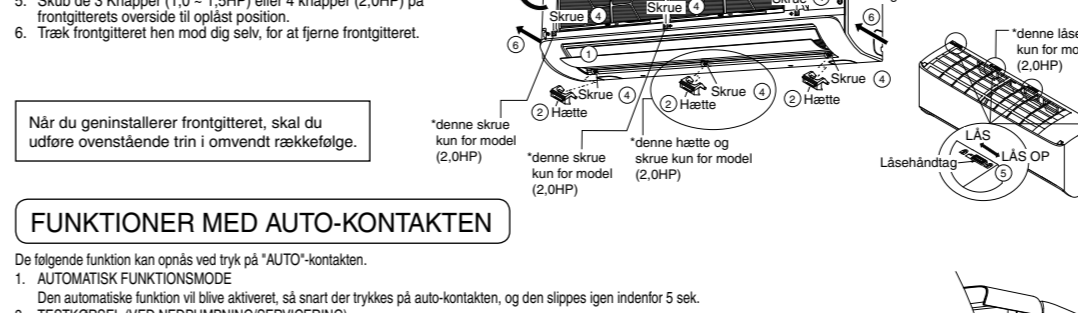
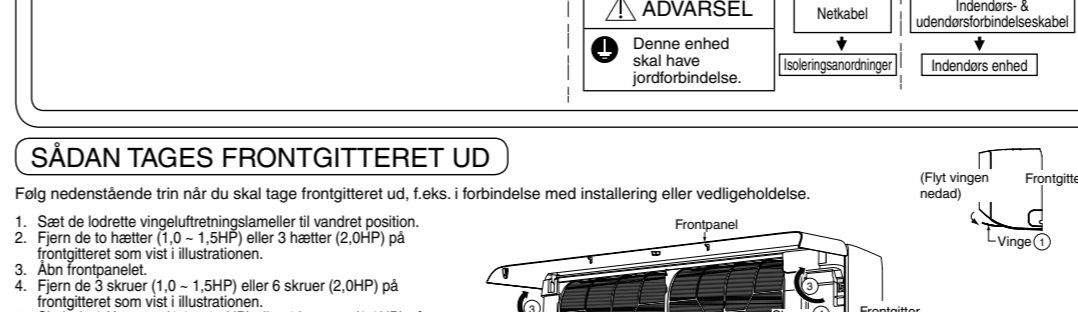
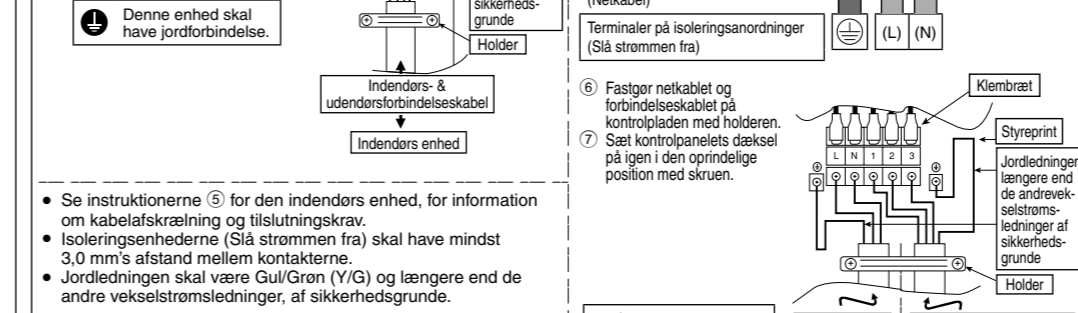
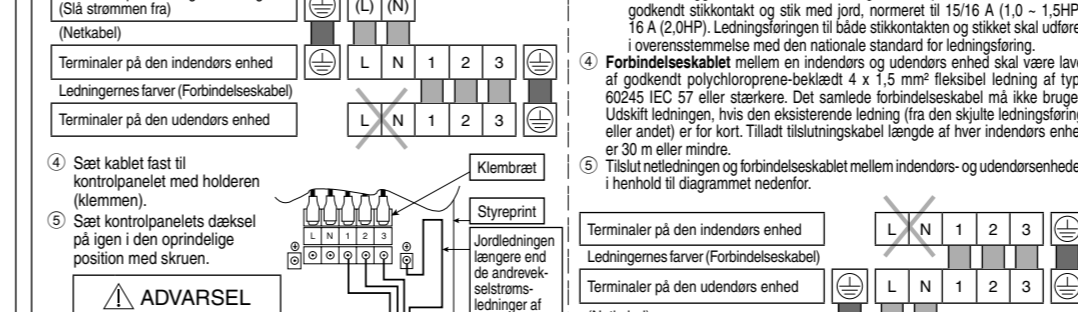
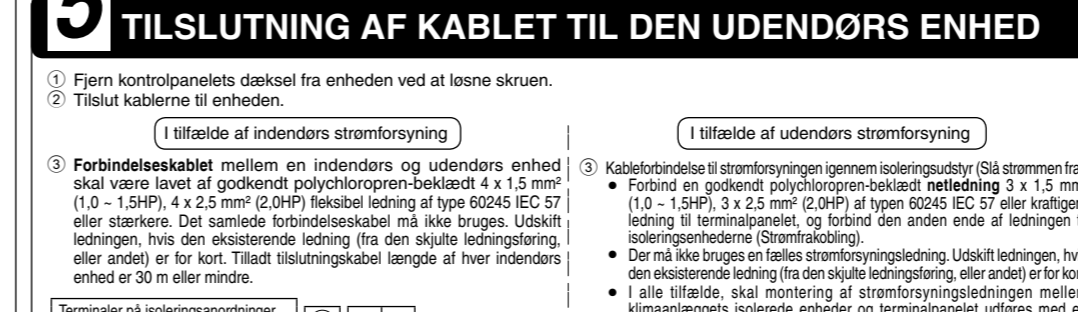

4 LUFTRYSSTEST PÅ KØLESYSTEMET

- Rens ikke luften med kølemidler, men brug en vakuumpumpe til at vakuere installationen.
- Der er ingen ekstra kølemiddel i udendørsenheden til luftrensning.

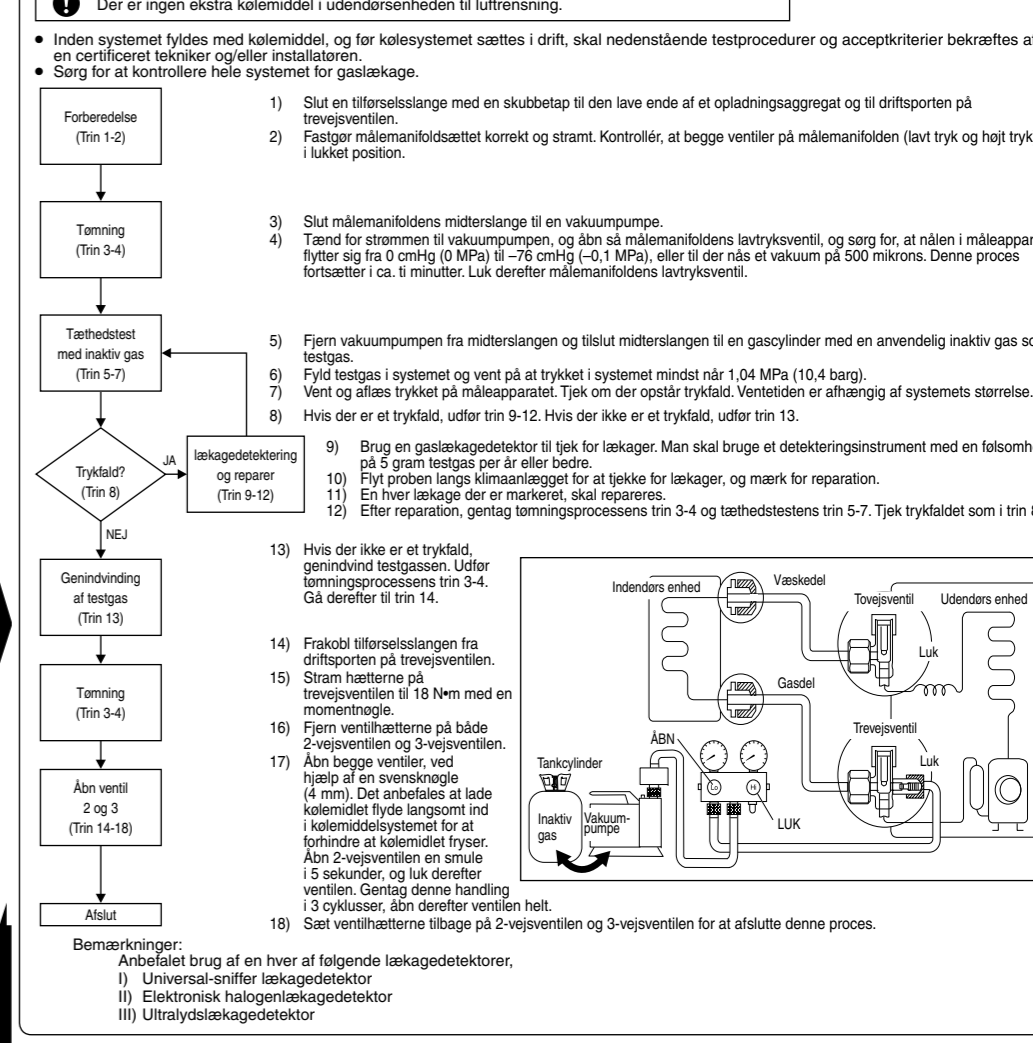

SÅDAN SKÆRER DU RØRENE OG GIVER DEM KRAVE

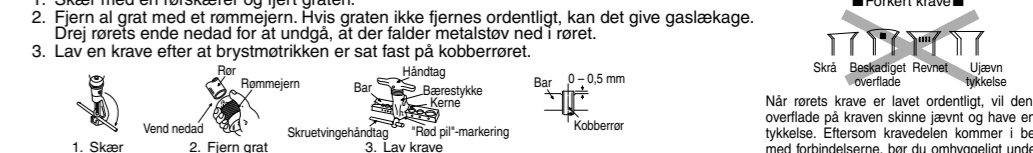

6 RØRISOLATION

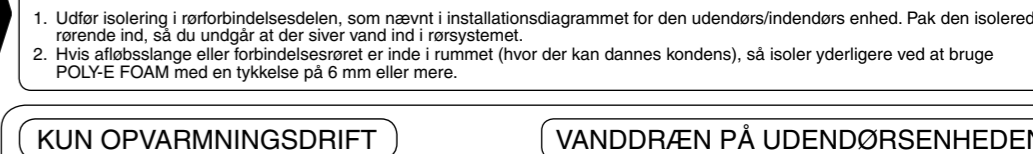

KUN OPVARMINGSDRIFT

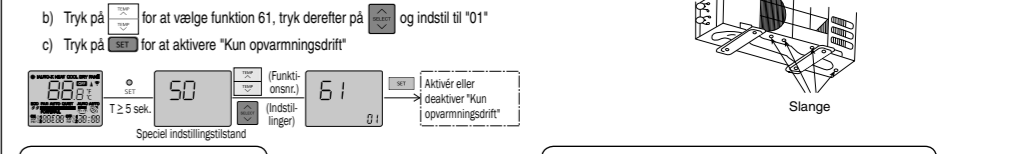

EVALUERING AF YDEEVENEN

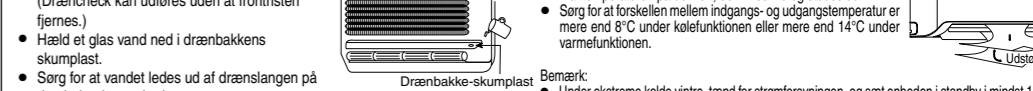

SÅDAN UDSKIFTES NETVERKSADAPTEREN



TILFÆLDE AF GENBRUG AF EKSISTERENDE KØLEMIDDELRØR

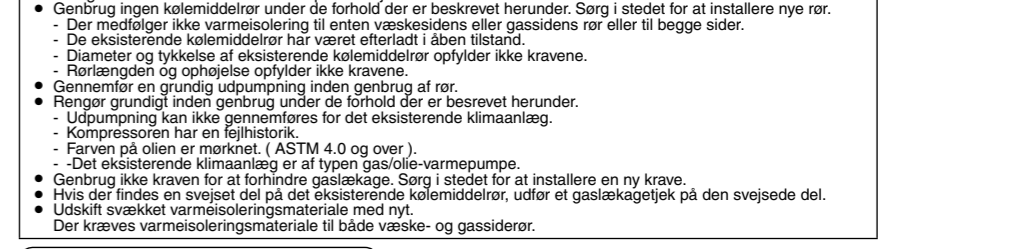

Korrekt udpumpningsmetode

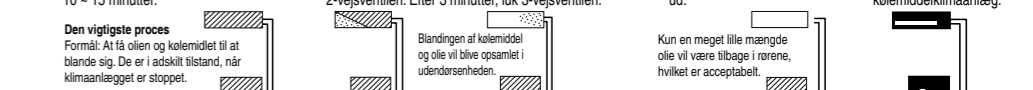

CHECKLISTE

- Slipper der gas ud ved brystmøtrikkerne?
- Er der udført varmeisolation ved brystmøtrikkerne?
- Er forbindelseskablet blevet sat ordentligt fast i terminalpanelet?
- Er forbindelseskablet blevet sat ordentligt fast i klemmen?
- Fungerer drænet?
- Slipper der gas ud ved brystmøtrikkerne?
- Er der udført varmeisolation ved brystmøtrikkerne?
- Er strømkredsløbet spænding passende i terminalpanelet?
- Høres der nogen unormale lyde i klemmen?
- Fungerer køle- varmeanlægget, som det skal?
- Fungerer termostaten som den skal?
- Fungerer fjernbetjenings LCD, som den skal?

Sisäyksikön

1 VALITSE PARAS SIJAINTI

(Kts. kohta "Valitse paras sijainti")

2 KUINKA KIINNITTÄÄ ASENNUSALUSTA

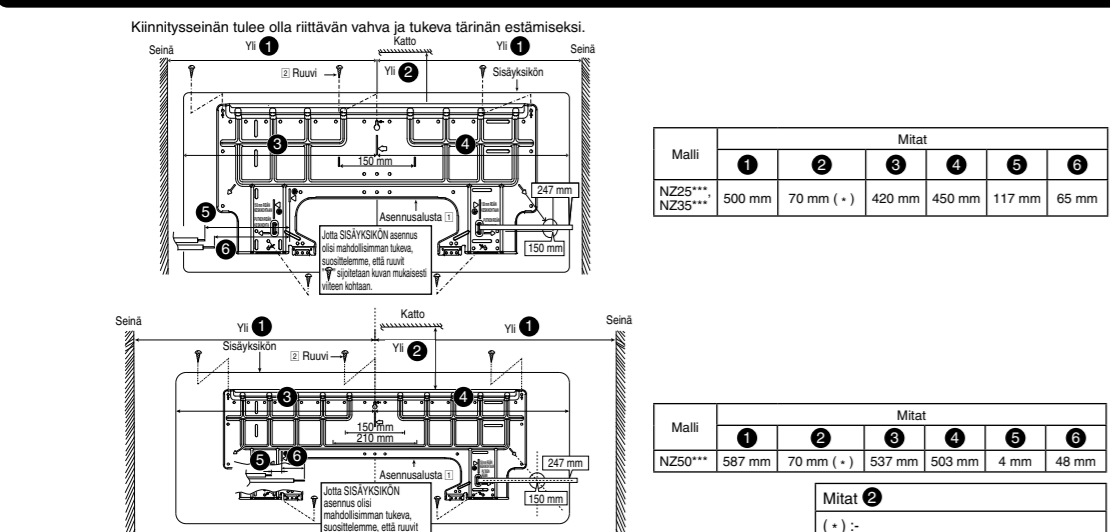

Asennuspaikan valinta on tärkeää. Varmista, että seinä on riittävästi vahva ja tukeva. Valitse paras sijainti ottaen huomioon huoneen muotoilu ja kaapelien siisteyden.

1. VALITSE PARAS SIJAINTI
 (Kts. kohta "Valitse paras sijainti")

2. KUINKA KIINNITTÄÄ ASENNUSALUSTA

1. Kinnitysseinän tulee olla riittävän vahva ja tukeva tämän estämiseksi.

Malli 1 2 3 4 5 6
 NZ25*** 500 mm 70 mm (-) 420 mm 450 mm 117 mm 65 mm

Mitat 1
 1. Kotelon etäisyys seinästä, 2. Kotelon syvyys, 3. Kotelon leveys, 4. Kotelon korkeus, 5. Kotelon paino, 6. Kotelon materiaali.

Asennuspaikan valinta on tärkeää. Varmista, että seinä on riittävästi vahva ja tukeva. Valitse paras sijainti ottaen huomioon huoneen muotoilu ja kaapelien siisteyden.

1. VALITSE PARAS SIJAINTI
 (Kts. kohta "Valitse paras sijainti")

2. KUINKA KIINNITTÄÄ ASENNUSALUSTA

1. Kinnitysseinän tulee olla riittävän vahva ja tukeva tämän estämiseksi.

Malli 1 2 3 4 5 6
 NZ25*** 587 mm 70 mm (-) 537 mm 503 mm 4 mm 48 mm

Mitat 2
 1. Kotelon etäisyys seinästä, 2. Kotelon syvyys, 3. Kotelon leveys, 4. Kotelon korkeus, 5. Kotelon paino, 6. Kotelon materiaali.

Asennuspaikan valinta on tärkeää. Varmista, että seinä on riittävästi vahva ja tukeva. Valitse paras sijainti ottaen huomioon huoneen muotoilu ja kaapelien siisteyden.

3 REIÄN PORAAMINEN SEINÄÄN JA PUTKIHOLKIN ASENTAMINEN

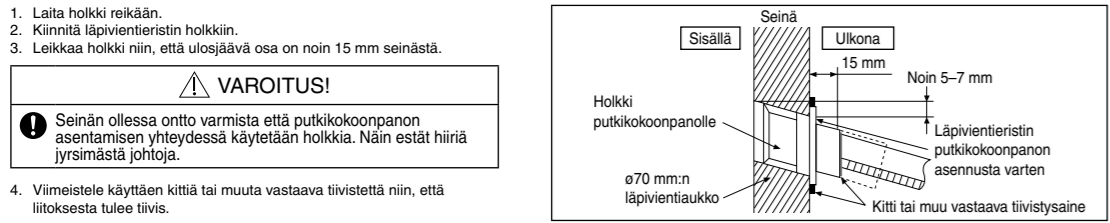

5 LIITÄ JOHTO SISÄLAITTEESEEN

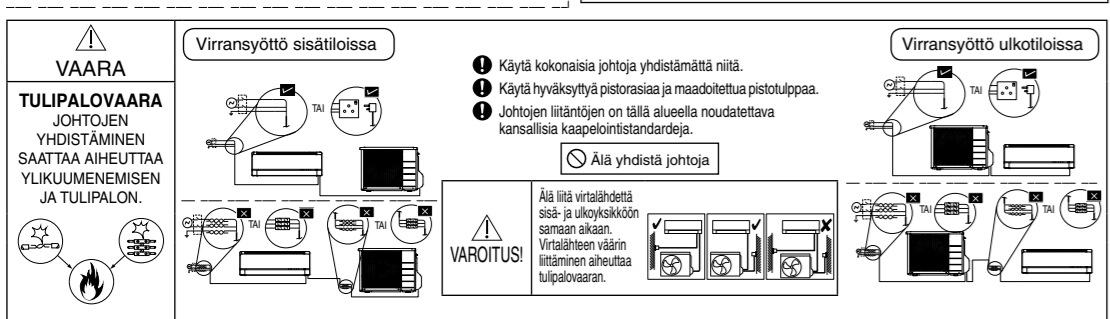
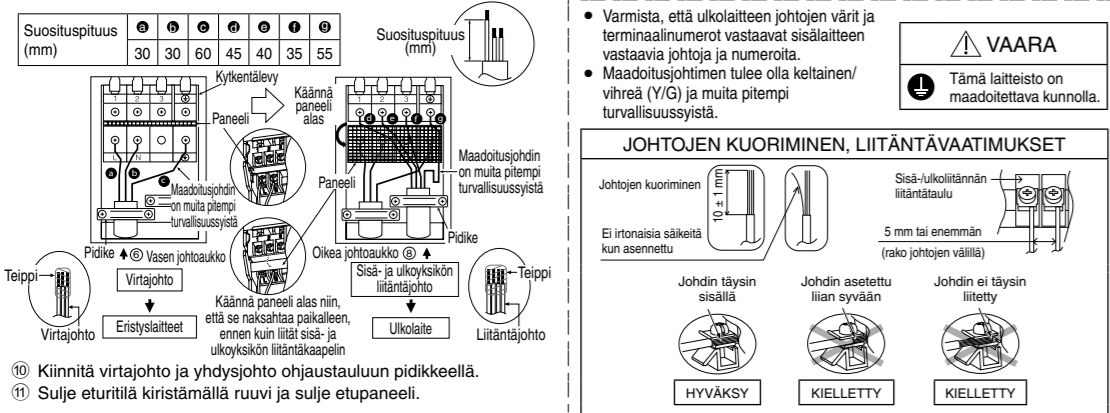
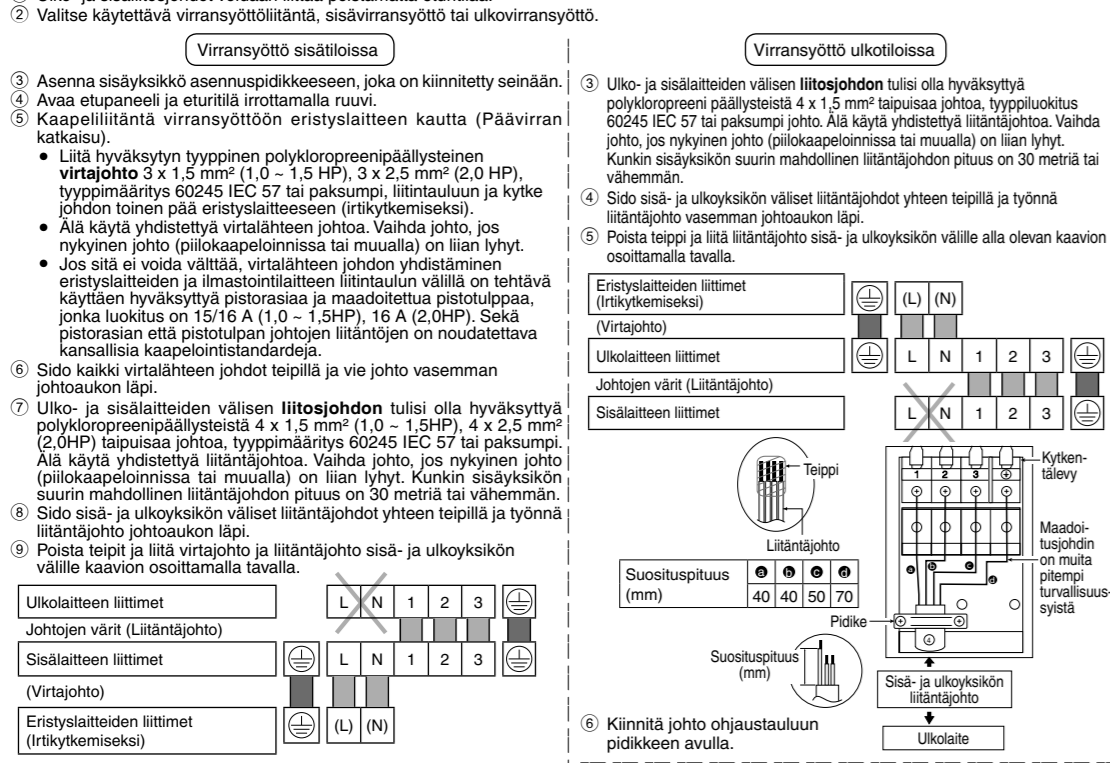

4 SISÄLAITTEEN ASENNUS

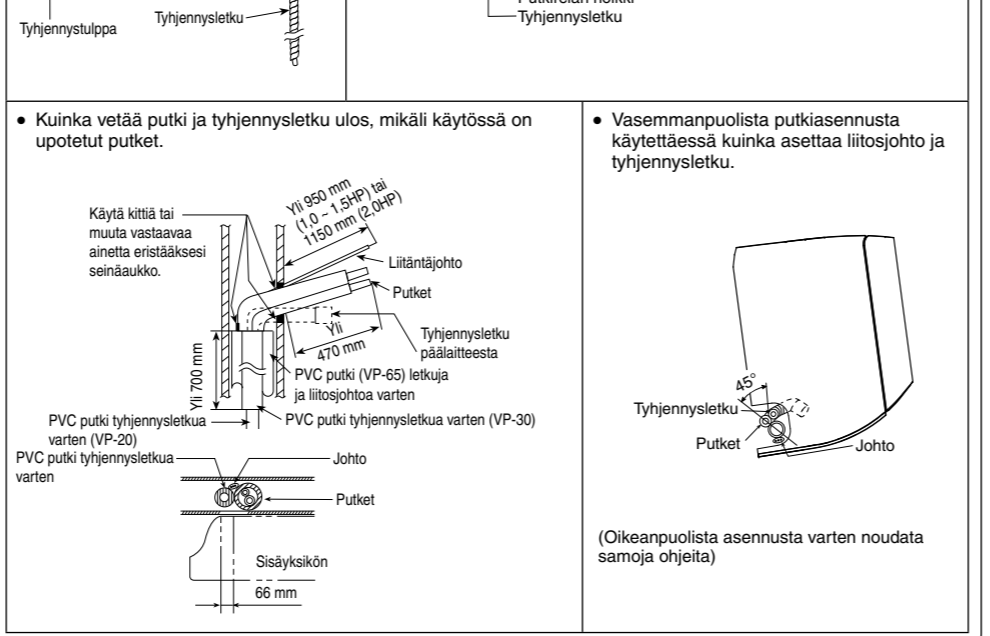
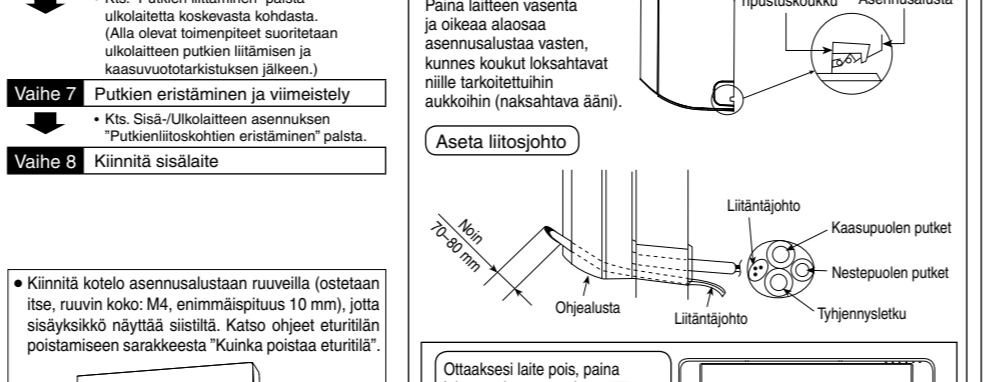
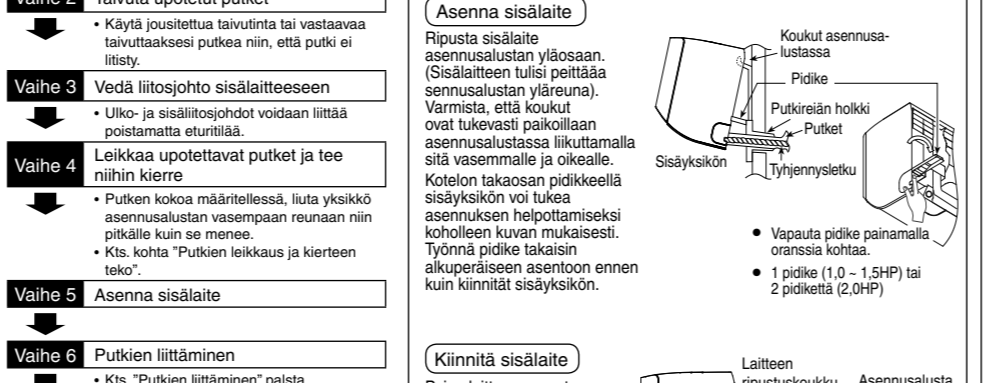
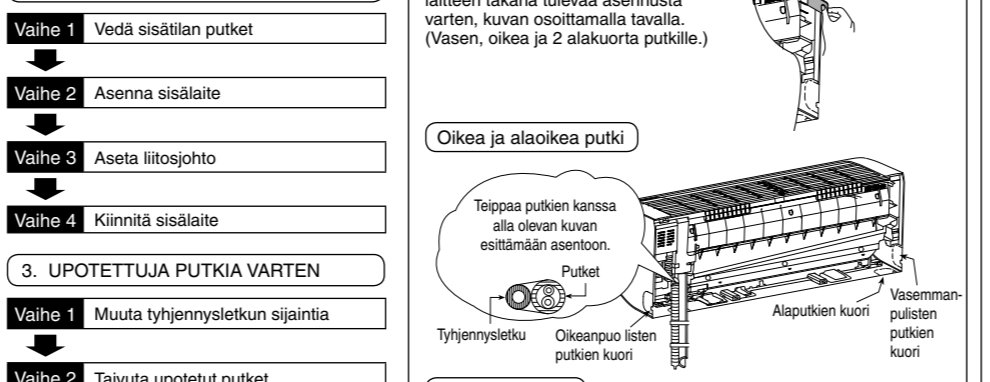
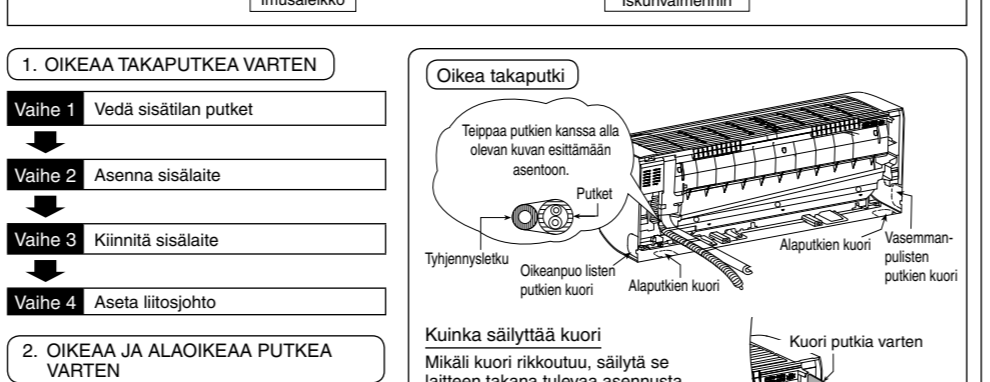
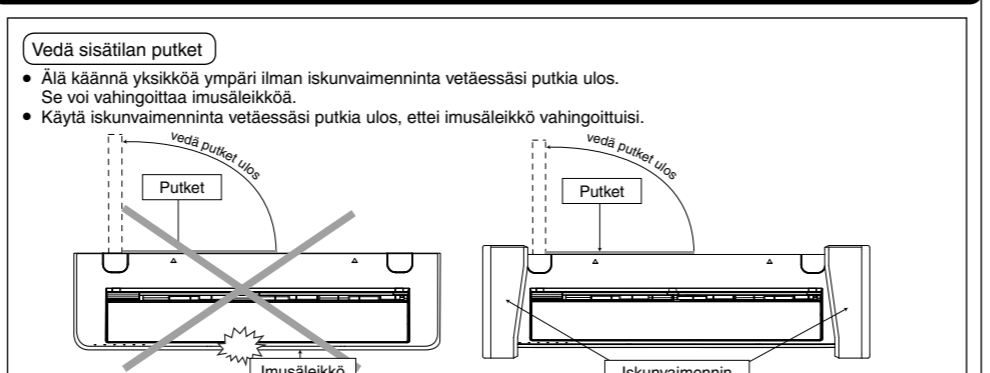

1 VALITSE PARAS SIJAINTI

(Kts. kohta "Valitse paras sijainti")

2 ULKOLAITTEEN ASENNUS

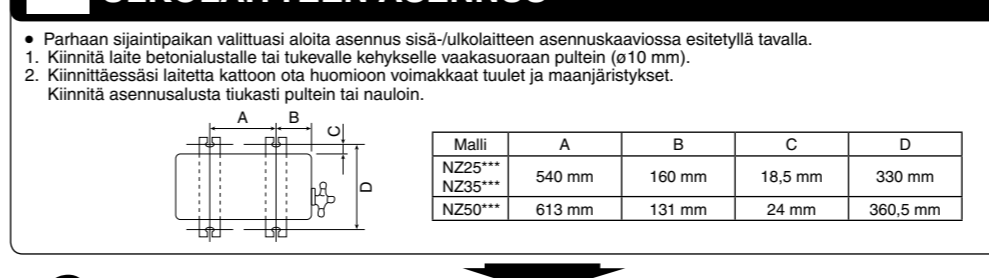

3 PUTKIEN LIITTÄMINEN

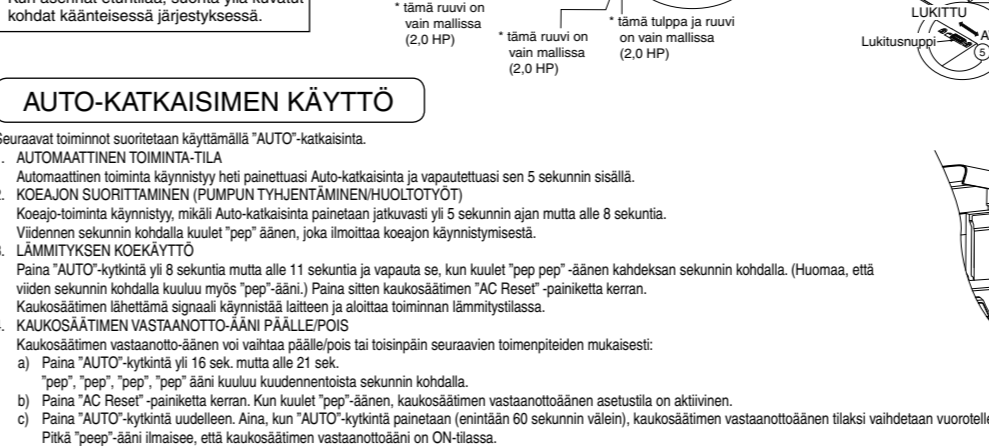
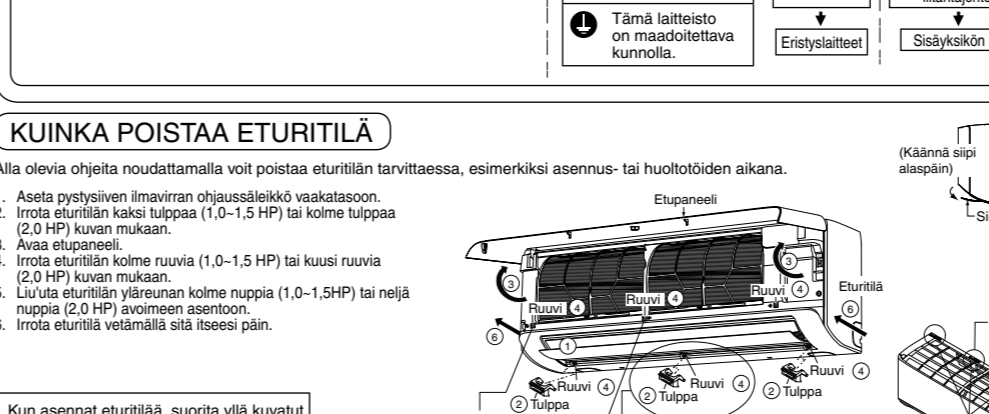
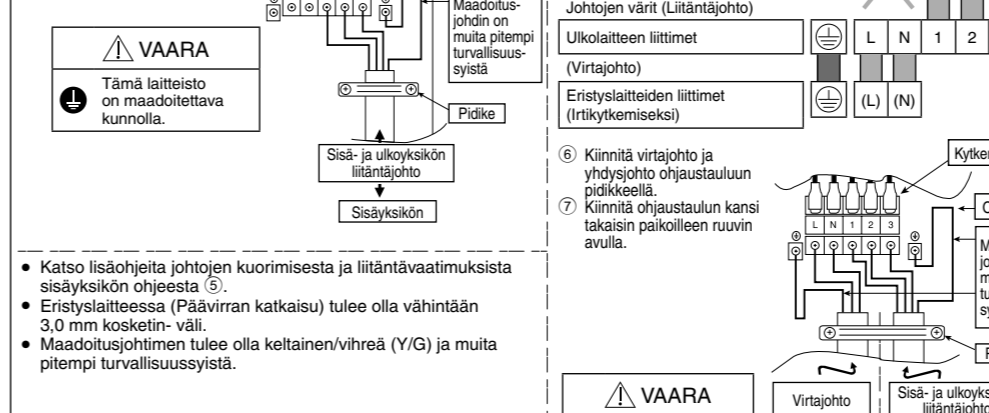
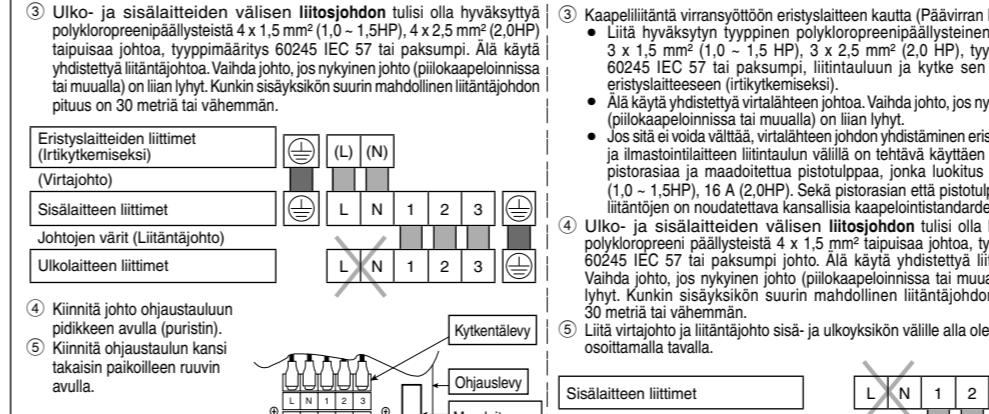
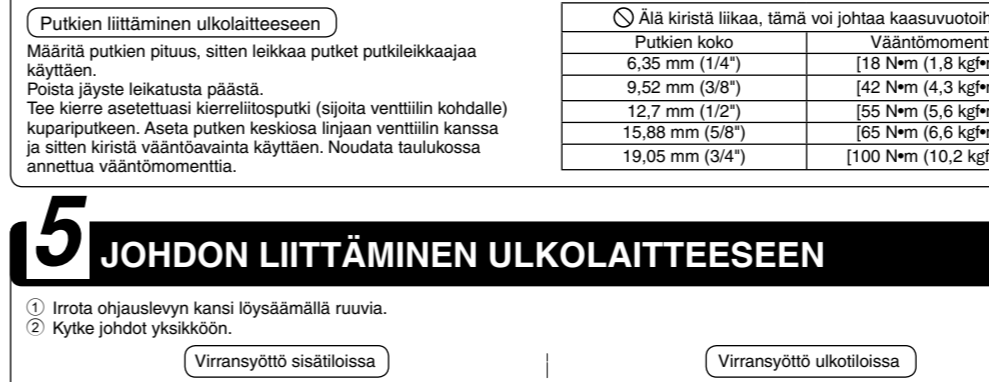
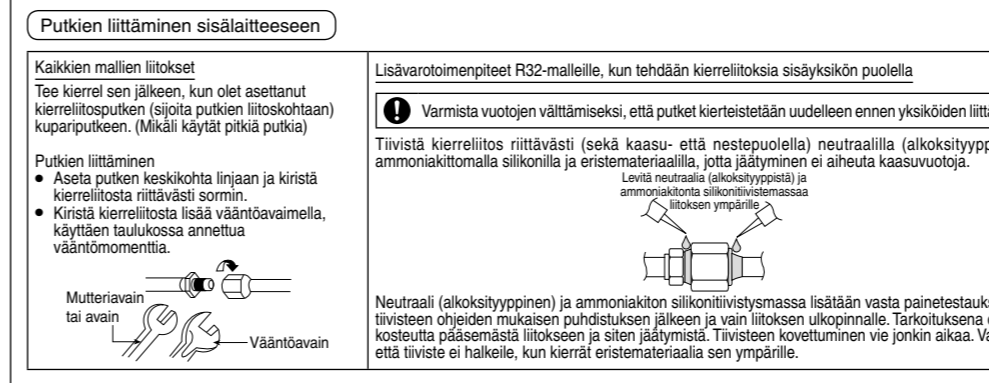

Ulkolaite

