

OWNER'S MANUAL



Split Air Conditioner Design Inverter Series (Arctic)



МОДЕЛИ: CH-S09FTXS-B CH-S12FTXS-B
CH-S09FTXS-M CH-S12FTXS-M
CH-S09FTXS-W CH-S12FTXS-W

For proper operation, please read and keep this manual carefully.

Designed by Cooper&Hunter International Corporation, Oregon, USA
www.cooperandhunter.com

Energy Label

Annual energy efficiency performance ratio is calculated by overall capacity and average operating time (approx 500 hours) multiplication in full-load cooling mode operation.

Cooling capacity

is device cooling capacity (demanded in kWh) in full-load cooling mode operation. ERR energy label index is ratio of cooling capacity to its electric energy input attainment. Energy label depends on ERR index rate.

Cooling mode energy label class

A	$3.2 \leq EER$
B	$3 \leq EER < 3.2$
C	$2.8 \leq EER < 3$
D	$2.6 \leq EER < 2.8$
E	$2.4 \leq EER < 2.6$
F	$2.2 \leq EER < 2.4$
G	$EER < 2.2$

* for split and multi-split systems only.

Heating capacity

is device heating capacity (demanded in kWh) in full-load heating mode operation. COP capacity index is ratio of heating capacity to its electric energy input attainment.

Energy label depends on COP index rate.

Heating mode energy label class

A	$3.6 \leq COP$
B	$3.4 \leq COP < 3.6$
C	$3.2 \leq COP < 3.4$
D	$2.8 \leq COP < 3.2$
E	$2.6 \leq COP < 2.8$
F	$2.4 \leq COP < 2.6$
G	$COP < 2.4$

* for split and multi-split systems only.

Device Energy Label

Manufacturer
Outdoor unit
Indoor unit

Air Conditioner



Cooling mode Energy Label Class

Maximum efficiency

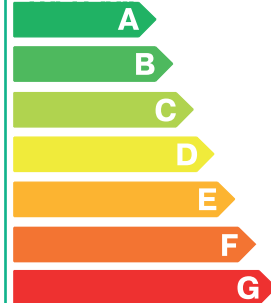

Minimum efficiency



◆ CONTENTS

Operation and maintenance

■ Precautions	1
■ Name of parts	6
■ Operation of Remote Controller	7
■ Emergency operation	12
■ Care and Cleaning	13
■ Troubleshooting	16

Installation service

■ Operation Tips.....	19
■ Notices for Installation	21
■ Installation dimension diagram	24
■ Installation of Indoor Unit	25
■ Installation of Outdoor Unit	28
■ Check after Installation and Operation Test	29
■ Installation and Maintenance of Healthy Filter(Optional)	30
■ Configuration of connection pipe and additional volume of refrigerant	31



Do not dispose this product as unsorted municipal waste.
Collection of such waste separately for special treatment
is necessary.

Precautions



Warning

Operation and Maintenance

- This appliance can be used by children aged from 8 years and above and persons with reduced physical, sensory or mental capabilities or lack of experience and knowledge if they have been given supervision or instruction concerning use of the appliance in a safe way and understand the hazards involved.
- Children shall not play with the appliance.
- Cleaning and user maintenance shall not be made by children without supervision.
- Do not connect air conditioner to multi-purpose socket. Otherwise, it may cause fire hazard.
- Do disconnect power supply when cleaning air conditioner. Otherwise, it may cause electric shock.
- If the supply cord is damaged, it must be replaced by the manufacturer, its service agent or similarly qualified persons in order to avoid a hazard.
- Do not wash the air conditioner with water to avoid electric shock.
- Do not spray water on indoor unit. It may cause electric shock or malfunction.
- After removing the filter, do not touch fins to avoid injury.
- Do not use fire or hair dryer to dry the filter to avoid deformation or fire hazard.

Precautions



Warning

- Maintenance must be performed by qualified professionals. Otherwise, it may cause personal injury or damage.
- Do not repair air conditioner by yourself. It may cause electric shock or damage. Please contact dealer when you need to repair air conditioner.
- Do not extend fingers or objects into air inlet or air outlet. It may cause personal injury or damage.
- Do not block air outlet or air inlet. It may cause malfunction.
- Do not spill water on the remote controller, otherwise the remote controller may be broken.
- When below phenomenon occurs, please turn off air conditioner and disconnect power immediately, and then contact the dealer or qualified professionals for service.
 - Power cord is overheating or damaged.
 - There's abnormal sound during operation.
 - Circuit break trips off frequently.
 - Air conditioner gives off burning smell.
 - Indoor unit is leaking.
- If the air conditioner operates under abnormal conditions, it may cause malfunction, electric shock or fire hazard.
- When turning on or turning off the unit by emergency operation switch, please press this switch with an insulating object other than metal.
- Do not step on top panel of outdoor unit, or put heavy objects. It may cause damage or personal injury.

Precautions



Warning

Attachment

- Installation must be performed by qualified professionals. Otherwise, it may cause personal injury or damage.
- Must follow the electric safety regulations when installing the unit.
- According to the local safety regulations, use qualified power supply circuit and circuit break.
- Do install the circuit break. If not, it may cause malfunction.
- An all-pole disconnection switch having a contact separation of at least 3mm in all poles should be connected in fixed wiring.
- Including an circuit break with suitable capacity, please note the following table. Air switch should be included magnet buckle and heating buckle function, it can protect the circuit-short and overload.
- Air Conditioner should be properly grounded. Incorrect grounding may cause electric shock.
- Don't use unqualified power cord.
- Make sure the power supply matches with the requirement of air conditioner. Unstable power supply or incorrect wiring or malfunction. Please install proper power supply cables before using the air conditioner.
- Properly connect the live wire, neutral wire and grounding wire of power socket.
- Be sure to cut off the power supply before proceeding any work related to electricity and safety.

Precautions



Warning

- Do not put through the power before finishing installation.
- If the supply cord is damaged, it must be replaced by the manufacturer, its service agent or similarly qualified persons in order to avoid a hazard.
- The temperature of refrigerant circuit will be high, please keep the interconnection cable away from the copper tube.
- The appliance shall be installed in accordance with national wiring regulations.
- Installation must be performed in accordance with the requirement of NEC and CEC by authorized personnel only.
- The air conditioner is the first class electric appliance. It must be properly grounding with specialized grounding device by a professional. Please make sure it is always grounded effectively, otherwise it may cause electric shock.
- The yellow-green wire in air conditioner is grounding wire, which can't be used for other purposes.
- The grounding resistance should comply with national electric safety regulations.
- The appliance must be positioned so that the plug is accessible.
- All wires of indoor unit and outdoor unit should be connected by a professional.
- If the length of power connection wire is insufficient, please contact the supplier for a new one. Avoid extending the wire by yourself.

Precautions



Warning

- For the air conditioner with plug , the plug should be reachable after finishing installation.
- For the air conditioner without plug, an circuit break must be installed in the line.
- If you need to relocate the air conditioner to another place, only the qualified person can perform the work. Otherwise, it may cause personal injury or damage.
- Select a location which is out of reach for children and far away from animals or plants.If it is unavoidable, please add the fence for safety purpose.
- The indoor unit should be installed close to the wall.

Working temperature range

	Indoor side DB/WB(°C)	Outdoor side DB/WB(°C)
Maximum cooling	32/23	43/26
Maximum heating	27/-	24/18

- The operating temperature range (outdoor temperature) for cooling only unit is 18°C ~48°C ; for heat pump unit is -25°C ~ 48°C .

◆ Name of Parts

Indoor unit

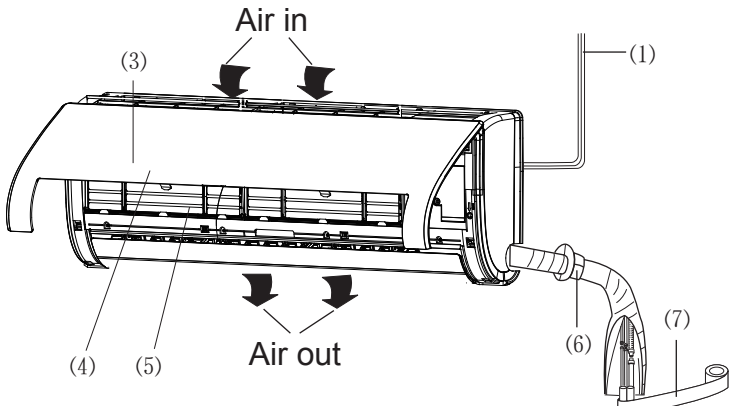

The icons displayed:

- ☀ : Cool
- 💧 : Dry
- ☀ : Heat
- ⏻ : Power
- BB : Set temp.



- (1) Power cord
- (2) Remote controller
- (3) Front panel
- (4) Filter
- (5) Horizontal louver
- (6) Wall pipe
- (7) Binding tape
- (8) Connection wires
- (9) Drain hose
- (10) Drain connector

Outdoor unit

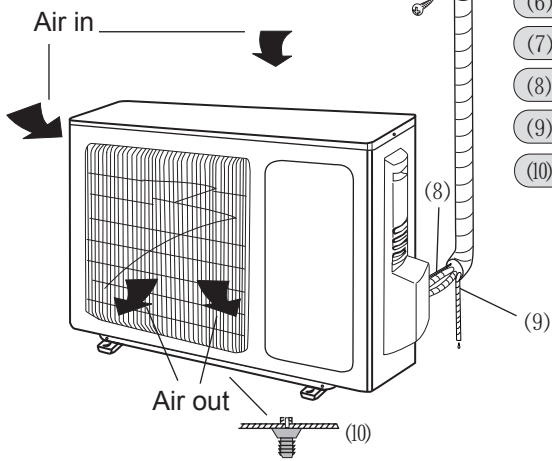

◆ Operation of Remote Controller



- 1 ON/OFF**
Press it to start or stop operation.
- 2 -** : Press it to decrease temperature setting.
- 3 +** : Press it to increase temperature setting.
- 4 MODE**
Press it to select operation mode (AUTO/COOL/DRY/FAN/HEAT).
- 5 FAN**
Press it to set fan speed.
- 6 SWING**
Press it set swing angle.
- 7 I FEEL**
- 8** 
Press it to set HEALTH or AIR function.
- 9 SLEEP**
- 10 TEMP**
- 11 QUIET**
Press it to set QUIET function.
- 12 CLOCK**
Press it set clock.
- 13 T-ON|T-OFF**
Press it to set auto-off/auto-on timer.
- 14 TURBO**
- 15 LIGHT**
Press it to turn on/off the light.
- 16 X-FAN**

◆ Operation of Remote Controller

Remote Controller Description

1 ON/OFF :

Press this button to turn on the unit .Press this button again to turn off the unit.

2 —

Press this button to decrease set temperature. Holding it down above 2 seconds rapidly decreases set temperature. In AUTO mode, set temperature is not adjustable.

3 + :

Press this button to increase set temperature. Holding it down above 2 seconds rapidly increases set temperature. In AUTO mode, set temperature is not adjustable.

4 MODE :

Each time you press this button,a mode is selected in a sequence that goes from AUTO, COOL, DRY, FAN, and HEAT *, as the following:



*Note: Only for models with heating function.

After energization, AUTO mode is defaulted. In AUTO mode, the set temperature will not be displayed on the LCD, and the unit will automatically select the suitable operation mode in accordance with the room temperature to make indoor room comfortable.

5 FAN :

This button is used for setting Fan Speed in the sequence that goes from AUTO, , , to , then back to Auto.

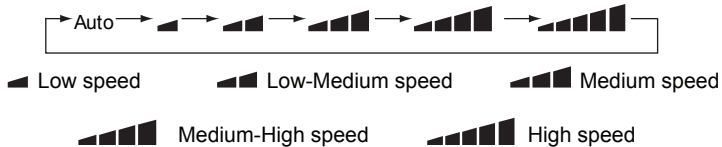

6 SWING:

Press this button to set up & down swing angle, which circularly changes as below:

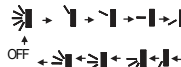

This remote controller is universal . If any command , or is sent out, the unit will carry out the command as

indicates the guide louver swings as:







7 I FEEL:

Press this button to turn on I FEEL function. The unit automatically adjust temperature according to the sensed temperature. Press this button again to cancel I FEEL function.



◆ Operation of Remote Controller

Remote Controller Description

8 /

Press this button to achieve the on and off of healthy and scavenging functions in operation status. Press this button for the first time to start scavenging function; LCD displays "". Press the button for the second time to start healthy and scavenging functions simultaneously; LCD displays "" and "". Press this button for the third time to quit healthy and scavenging functions simultaneously. Press the button for the fourth time to start healthy function; LCD display "". Press this button again to repeat the operation above.

9 SLEEP:

- Press this button, can select Sleep 1 (), Sleep 2 (), Sleep 3 () and cancel the Sleep, circulate between these, after electrified, Sleep Cancel is defaulted.
- Sleep 1 is Sleep mode 1, in Cool, Dehumidify modes: sleep status after run for one hour, the main unit setting temperature will increase 1 °C, setting temperature increased 2 °C, the unit will run at this setting temperature; In Heat mode: sleep status after run for one hour, the setting temperature will decrease 1 °C, 2 hours, setting temperature will decrease 2 °C, then the unit will run at this setting temperature.
- Sleep 2 is sleep mode 2, that is air conditioner will run according to the presetting a group of sleep temperature curve.

- Sleep 3- the sleep curve setting under Sleep mode by DIY:

(1) Under Sleep 3 mode, press "Turbo" button for a long time, remote control enters into user individuation sleep setting status, at this time, the time of remote control will display "1hour", the setting temperature "88" will display the corresponding temperature of last setting sleep curve and blink (The first entering will display according to the initial curve setting value of original factory);

(2) Adjust "+" and "-" button, could change the corresponding setting temperature, after adjusted, press "Turbo" button for confirmation;

(3) At this time, 1hour will be automatically increased at the timer position on the remote control, (that are "2hours" or "3hours" or "8hours"), the place of setting temperature "88" will display the corresponding temperature of last setting sleep curve and blink;

(4) Repeat the above step (2) ~ (3) operation, until 8hours temperature setting finished, sleep curve setting finished, at this time, the remote control will resume the original timer display; temperature display will resume to original setting temperature.

- Sleep3- the sleep curve setting under Sleep mode by DIY could be inquired:

The user could accord to sleep curve setting method to inquire the presetting sleep curve, enter into user individuation sleep setting status, but do not change the temperature, press "Turbo" button directly for confirmation. Note: In the above presetting or enquiry procedure, if continuously within 10s, there is no button pressed, the sleep curve setting within 10s, there is no button pressed, the sleep curve setting status will be automatically quit and resume to display the original displaying. In the presetting or enquiry procedure, press "ON/OFF" button, "Mode" button, "Timer" button or "Sleep" button, the sleep curve setting or enquiry status will quit similarly.

◆ Operation of Remote Controller

10 TEMP:

Press this button, could select displaying the indoor setting temperature or indoor ambient temperature. When the indoor unit firstly power on it will display the setting temperature, if the temperature's displaying status is changed from other status to "🌡️", displays the ambient temperature, 3s later or within 3s, it receives other remote control signal that will return to display the setting temperature. if the users haven't set up the temperature displaying status, that will display the setting temperature.

11 QUIET:

Press this button, the Quiet status is under the Auto Quiet mode (display "🔇" signal) and Quiet mode (display "🔇" signal) and Quiet OFF (there is no signal of "🔇" displayed), after powered on, the Quiet OFF is defaulted.

12 CLOCK :

Press CLOCK button, blinking ⌚ . Within 5 seconds, pressing + or - button adjusts the present time. Holding down either button above 2 seconds increases or decreases the time by 1 minute every 0.5 second and then by 10 minutes every 0.5 second. During blinking after setting, press CLOCK button again to confirm the setting, and then ⌚ will be constantly displayed.

13 T-ON | T-OFF :

Press T-ON button to initiate the auto-ON timer. To cancel the auto-timer program, simply press this button again.

After press of this button, ⌚ disappears and "ON "blinks .00:00 is displayed for ON time setting. Within 5 seconds, press + or - button to adjust the time value. Every press of either button changes the time setting by 1 minute. Holding down either button rapidly changes the time setting by 1 minute and then 10 minutes. Within 5 Seconds after setting, press TIMER ON button to confirm.

Press T-OFF button to initiate the auto-off timer. To cancel the auto-timer program, simply press the button again. TIMER OFF setting is the same as TIMER ON.

14 TURBO:

Press this button to activate / deactivate the Turbo function which enables the unit to reach the preset temperature in the shortest time. In COOL mode, the unit will blow strong cooling air at super high fan speed. In HEAT mode, the unit will blow strong heating air at super high fan speed.

15 LIGHT:

Press LIGHT button to turn on the display's light and press this button again to turn off the display's light. If the light is turned on, 💡 is displayed. If the light is turned off, 💡 disappears.



16 X-FAN:

Pressing X-FAN button in COOL or DRY mode, the icon 🌀 is displayed and the indoor fan will continue operation for 2 minutes in order to dry the indoor unit even though you have turned off the unit.

After energization, X-FAN OFF is defaulted. X-FAN is not available in AUTO, FAN or HEAT mode.

◆ Operation of Remote Controller

17 Combination of "+" and "-" buttons: About lock

Press "+" and "-" buttons simultaneously to lock or unlock the keypad. If the remote controller is locked,  is displayed. In this case, pressing any button,  blinks three times.

18 Combination of "MODE" and "-" buttons : About switch between Fahrenheit and centigrade

At unit OFF, press "MODE" and "-" buttons simultaneously to switch between °C and °F .

19 Combination of "TEMP" and "CLOCK" buttons : About Energy-saving Function

Press "TEMP" and "CLOCK" simultaneously in COOL mode to start energy-saving function. Nixie tube on the remote controller displays "SE". Repeat the operation to quit the function.

20 Combination of "TEMP" and "CLOCK" buttons : About 8°C Heating Function

Press "TEMP" and "CLOCK" simultaneously in HEAT mode to start 8°C Heating Function. Nixie tube on the remote controller displays "8" and a selected temperature of "8°C". (46°F if Fahrenheit is adopted). Repeat the operation to quit the function.

21 About Back-lighting Function

The unit lights for 4s when energizing for the first time, and 3s for later press.

Replacement of Batteries

1.Remove the battery cover plate from the rear of the remote controller.

(As shown in the figure)

2.Take out the old batteries.

3.Insert two new AAA1.5V dry batteries, and pay attention to the polarity.

4. Reinstall the battery cover plate.

★ Notes:

- When replacing the batteries, do not use old or different types of batteries, otherwise, it may cause malfunction.
- If the remote controller will not be used for a long time, please remove batteries to prevent batteries from leaking.
- The operation should be performed in its receiving range.
- It should be kept 1m away from the TV set or stereo sound sets.
- If the remote controller does not operate normally, please take the batteries out and reinsert them after 30 seconds.If it still can't operate properly, replace the batteries.

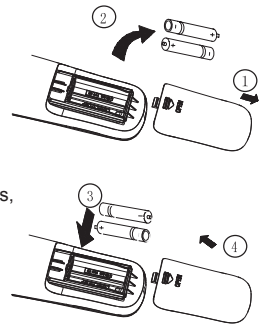

Sketch map for replacing batteries

◆ Emergency Operation

Emergency Operation

When the remote controller is lost or damaged, please use the manual switch on the main unit. In that case, the unit will operate in AUTO mode and the temperature setting or fan speed can not be changed.

The manual switch can be operated as below:

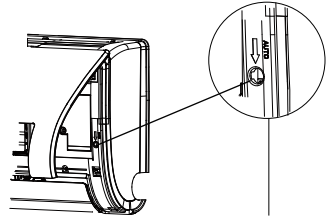

Manual switch

- Turn on the unit: Press AUTO/STOP button to enter AUTO mode.
The microprocessor will select the mode (COOL, HEAT, FAN) automatically according to the room temperature for reaching comfortable effect.
- Turn off the unit: Press the AUTO/STOP button to switch off the unit.
- The operation mode is shown in the following table.

Mode	Model	Temperature setting	Airflow rate
AUTO	COOLING	25°C (COOL,FAN)	AUTO
AUTO	HEAT PUMP	25°C (COOL,FAN)	AUTO
AUTO	HEAT PUMP	20°C (HEAT)	AUTO

- This switch is to be applied when the remote controller is missing.

Care and Cleaning



Caution

- Disconnect the power supply before cleaning and maintenance.
- Do not splash water on the units for cleaning, as electric shocks may occur.
- Wipe the units with a dry soft cloth, or a cloth slightly moistened with water or cleaner (not with volatile liquid such as thinner or gasoline).

Cleaning the Front Panel

Remove the front panel. Dip a piece of cloth into the water colder than 45 °C and dry it. Then wipe the dirty part of front panel.

Note: Do not immerse the front panel into water so as to protect microprocessor components and circuit diagram on the front panel.

Cleaning the Air Filter (every 3 months)

Note: If the air conditioner operates under dusty environment, the frequency of cleaning air filter shall increase correspondingly. When the filter is removed, do not touch the fins of the indoor unit with fingers for fear of scalding.

① Take down the air filter

Press the clasp as shown by arrow (1) to loosen the lower end of clasps until a sound of "crack" is heard; press the clasp as shown by arrow (2) to open the upper end of clasp; open the panel and then pull the filter downward to remove it.(As shown in figa and b)

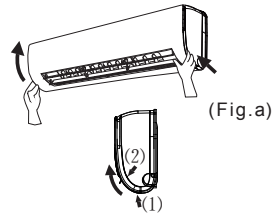

② Clean the air filter

Clean the filter with a vacuum cleaner or wash the filter with water. If the filter is very dirty (such as oil stain), please clean it with the mixture of warm water (<math><45\text{ }^{\circ}\text{C}</math>) and neutral abluent and then dry it up in the shade.

Note: Never use water above 45 °C to clean the air filter as it may cause deformation or discoloration.

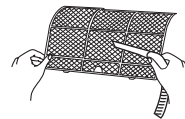
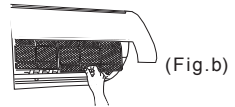

③ Reinstall the air filter

Install the air filter along arrow (1) direction and then buckle the panel cover along arrow (2).

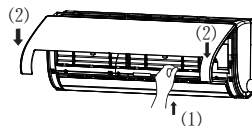

Care and Cleaning

Installation and Maintenance for Healthy filter

1. Press the clasp as shown by arrow (1) to loosen the clasps at the lower end until a sound of "crack" is heard; press the clasp as shown by arrow (2) to open the clasps at the upper end; open the panel and then pull the filter downward to remove it. (As shown in fig a)

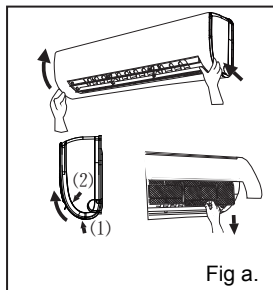

2. Install the healthy filter on the air filter (as shown in fig b). If the healthy filter fails to be installed on the air filter, please install the healthy filter on the front case (As shown in fig c) .

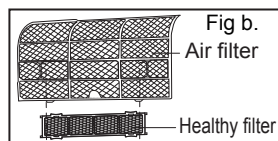

3. Install the air filter along arrow (1) direction and then buckle the panel cover along arrow (2). (As shown in fig d)

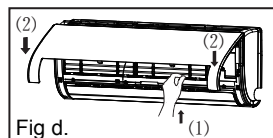
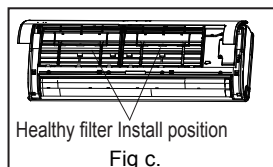

Clean and Maintenance for Healthy Filter

Please remove the healthy filter before cleaning and reinstall it well after cleaning according to the installation instruction. Please note that the silver ion filter shall NOT be washed by water. Active carbon filter, photocatalytic filter, LTC catalyst and formaldehyde-killer filter can be washed by water, but shall not be scrubbed with a brush or hard object. When washing is completed, dry the filter in shade rather than wipe with a rag.

Service Life for Healthy Filter

The general service life for healthy filter is one year under normal operation. As to silver ion filter, it is ineffective when the surface turns black (or green) .

- This complementary instruction is only referred for the unit with healthy filter. The graphs in this complementary instruction may be different from the actual product, please refer to the actual product. Please refer to the actual delivery for the quantity of healthy filter.

◆ Care and Cleaning

Check before Use

- ① Make sure that nothing obstructs the air inlet and air outlet of indoor and outdoor units.
- ② Make sure there is effective grounding.
- ③ Make sure the batteries for remote controller are replaced.
- ④ Make sure the installation support for outdoor unit is in good condition. If it's damaged, please contact GREE appointed maintenance center. If there is rust on the outdoor unit, please apply some paint to the rusty spot to avoid spreading. BE CAREFUL when painting!

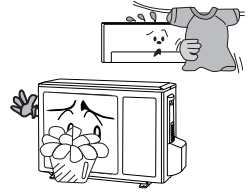

Maintenance after Use





- ① Disconnect the power for the air conditioner.
- ② Clean the filter and the body of indoor and outdoor units.
- ③ Remove the dust and other objects on the outdoor unit.
- ④ Make sure the installation support for outdoor unit is in good condition. If it's damaged, please contact GREE appointed maintenance center. If there is rust on the outdoor unit, please apply some paint to the rusty spot to avoid spreading. BE CAREFUL when painting.
- ⑤ Indoor and outdoor units can be wrapped by special protective bags to avoid rain and dust getting into the units to erode them.

◆ Troubleshooting

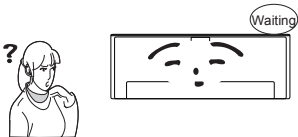

CAUTION

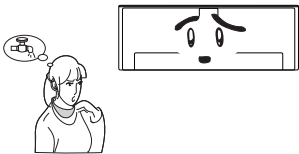
The air conditioner is not expected to be serviced by users. Incorrect repair may cause electric shock or fire, so please contact an authorized service center for professional service. The following checks prior to contact may save your time and money.

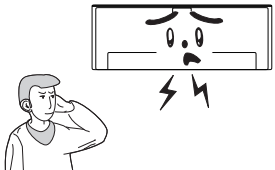
Phenomenon	Troubleshooting
<p>The unit does not operate:</p> 	<ul style="list-style-type: none"> ● The unit does not operate if it is turned on immediately after being turned off. This is to protect the unit. You are expected to wait for about 3 minutes.
<p>Odours are emitted:</p> 	<ul style="list-style-type: none"> ● Some odours may be emitted from the indoor unit. This is the result of room smells (such as furniture, tobacco, ect.) which have been taken into the air conditioner. ● Consult authorized service center for cleaning if the odours still exist.
<p>"Water flowing" noise:</p> 	<ul style="list-style-type: none"> ● The swishing noise like water flowing is the sound of refrigerant flowing inside the unit.
<p>Mist is emitted in COOL mode</p> 	<ul style="list-style-type: none"> ● During cooling operation, a thin mist may be seen emitted from the indoor unit due to high room temperature and humidity. After a period of time, the mist will disappear with the decrease of room temperature and humidity.
<p>Cracking noise:</p> 	<ul style="list-style-type: none"> ● This is the sound of friction caused by expansion and/or contraction of panel or other parts due to the change of temperature.

◆ Troubleshooting

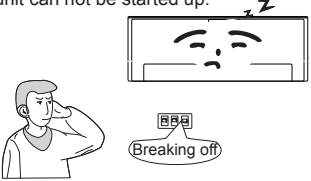
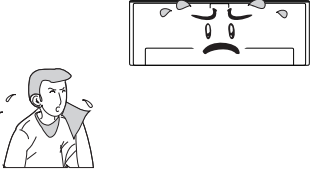
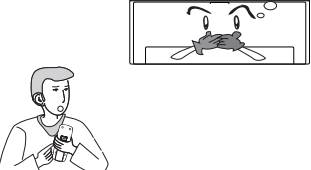
Phenomenon	Troubleshooting
<p>The unit can not be started up:</p> 	<ul style="list-style-type: none"> ● Is the power cut off? ● Is the power plug loose? (If applicable) ● Is the circuit protection device tripped off? ● Is voltage higher or lower? (Tested by professionals) ● Is the TIMER correctly used?
<p>Cooling/Heating effect is poor:</p> 	<ul style="list-style-type: none"> ● Is temperature setting appropriate? ● Is the inlet or outlet blocked? ● Is the filter dirty? ● Is the window or the door open? ● Is low fan speed set? ● Are there heat sources in the room?
<p>Remote controller is not available:</p> 	<ul style="list-style-type: none"> ● Check if there is magnetic or electrical interference near the unit that may affecting operation of the controller. In this case, pull the plug out and reinsert it. ● Is the remote controller within its operating range or obstructed? Check the condition of the batteries and replace them if necessary. ● Check if the remote controller is damaged.
<p>Water leakage of indoor unit :</p>	<ul style="list-style-type: none"> ● The humidity is high. ● Condensate overflows. ● Drain hose is loose.
<p>Water leakage of outdoor unit :</p>	<ul style="list-style-type: none"> ● During cooling operation, condensate is generated around the pipes and connection joints. ● During defrosting operation, the thaw water flows out. ● During heating operation, the water on the heat exchanger drips out.
<p>Noise from indoor unit.</p>	<ul style="list-style-type: none"> ● The noise emitted when the fan or compressor relay is switching on or off. ● When the defrosting operation is started or stopped, there is a sound of refrigerant flowing in the reverse direction.

◆ Troubleshooting

Phenomenon	Troubleshooting
Indoor unit can not blow air:	<ul style="list-style-type: none"> ● In HEAT mode, when the temperature of indoor heat exchanger is very low, air flow is stopped in order to prevent cold air. (Within 2 minutes) ● In HEAT mode, when the outdoor temperature is low or humidity is high, frost will be formed on the outdoor heat exchanger. The unit will defrost automatically and indoor unit will stop blowing air for 3-12 minutes. ● During defrosting operation, water or vapour may be emitted. ● In DRY mode, the indoor fan will stop blowing air for 3-12 minutes in order to avoid condensate being vaporised again.
Moisture on air outlet :	<ul style="list-style-type: none"> ● If the unit operates at high humidity for a long time, moisture will be generated on the air outlet grill and then drip off.
C5: Malfunction of connector jumper:	<ul style="list-style-type: none"> ● Check if the connector jumper contacts properly. If the PCB is to be replaced, please take off the old for the new PCB.
F1: Malfunction of indoor ambient temperature sensor	<ul style="list-style-type: none"> ● Check if indoor room temperature sensor is connected properly.
F2: Malfunction of evaporator temperature sensor	<ul style="list-style-type: none"> ● Check if the evaporator temperature is connected properly.



If any one of the following situations occurs, immediately stop all operations, cut off the power supply, and contact the authorized personnel

- There is harsh sound during operation.
- Strong odours are emitted during operation.
- Water is leaking from the unit.
- The air switch or protection switch often trips.
- Water or other liquid is splashed into the unit.
- Power cord and power plug is overheating.

Stop operation
and cut off the power supply.

◆ Operation Tips

Cooling Operation

Principle:

Air conditioners absorb heat in the room and transmit it to the outdoor unit so that the room temperature is decreased. The cooling capacity will increase or decrease according to outdoor ambient temperature.

Freeze Protection:

If the unit is operating in COOL mode and in low ambient temperature, frost may form on the heat exchanger. When indoor heat exchanger temperature decreases below zero, compressor will stop operation to protect the unit.

Heating Operation

Principle:

* Air conditioners absorb heat from outdoors and transmit it to the indoor unit, increasing room temperature. The heating capacity will decrease at low ambient temperature.

Defrosting:

- * When outdoor temperature is low but humidity is high, frost may form on the outdoor unit during extended operation, affecting heating efficiency. The air conditioner may stop operation during auto defrosting operation.
- * During auto defrosting, the fan motors of indoor unit and outdoor unit will stop.
- * During defrosting, the indoor indicator displays “❄” and the outdoor unit may emit vapor. This is not malfunction.
- * After defrosting is finished, the heating operation will recover automatically.

Cold Blow Prevention:

In HEAT mode, the indoor fan will not operate in order to prevent cold air blowing out (within 2 minutes) if indoor heat exchanger doesn't reach a certain temperature under the following three states:

1. Heating operation starts;
2. After Auto Defrosting is finished;
3. Heating at low temperature.

Gentle Breeze

In the following situations, the indoor unit may blow gentle breeze, and the horizontal louver rotates to a certain position:

1. In HEAT mode, the compressor does not start operation after the unit is turned on.
2. In HEAT mode, the temperature reaches the set value and the compressor has stopped operation for about 1minutes.

◆ Operation Tips

Tips for energy saving:

- * Do not overcool or overheat.
Setting temperature at a moderate level helps energy saving.
- * Cover windows with a blind or a curtain.
Blocking sunlight and air from outdoors is favorable for cooling (heating).
- * Clean air filters once per two weeks.
Clogged air filters lead to inefficient operation and energy waste.

Tip for relative humidity:

Condensate is likely to form at the air outlet if cooling or drying for a long time when the relative humidity is more than 80% (with doors and windows open).

◆ Notices for Installation



Caution

1. The unit should be installed only by authorized service center according to local or government regulations and in compliance with this manual.
2. Before installing, please contact with local authorized maintenance center. If the unit is not installed by the authorized service center, the malfunction may not be solved due to inconvenient contact between the user and the service personnel.
3. When removing the unit to the other place, please firstly contact with the local authorized service center.
4. Warning: Before obtaining access to terminals, all supply circuits must be disconnected.
5. For appliances with type Y attachment, the instructions shall contain the substance of the following. If the supply cord is damaged, it must be replaced by the manufacturer, its service agent or similarly qualified persons in order to avoid a hazard.
6. The appliance must be positioned so that the plug is accessible.
7. The temperature of refrigerant line will be high; please keep the interconnection cable away from the copper tube.
8. The instructions shall state the substance of the following:
This appliance is not intended for use by persons (including children) with reduced physical, sensory or mental capabilities, or lack of experience and knowledge, unless they have been given supervision or instruction concerning use of the appliance by a person responsible for their safety.
Children should be supervised to ensure that they do not play with the appliance.

Installation Site Instructions

Proper installation site is vital for correct and efficient operation of the unit. Avoid the following sites where:

- strong heat sources, vapours, flammable gas or volatile liquids are emitted.
- high-frequency electro-magnetic waves are generated by radio equipment, welders and medical equipment.
- salt-laden air prevails (such as close to coastal areas).
- the air is contaminated with industrial vapours and oils.
- the air contains sulphures gas such as in hot spring zones.
- corrosion or poor air quality exists.

◆ Notices for Installation

Installation Site of Indoor Unit

1. The air inlet and outlet should be away from the obstructions. Ensure the air can be blown through the whole room.
2. Select a site where the condensate can be easily drained out, and where it is easily connected to outdoor unit.
3. Select a place where it is out of reach of children.
4. Select a place where the wall is strong enough to withstand the full weight and vibration of the unit.
5. Be sure to leave enough space to allow access for routine maintenance. The installation site should be 250cm or more above the floor.
6. Select a place about 1m or more away from TV set or any other electric appliance.
7. Select a place where the filter can be easily taken out.
8. Make sure that the indoor unit is installed in accordance with installation dimension instructions.
9. Do not use the unit in the laundry or by swimming pool etc.

Installation Site of Outdoor Unit

1. Select a site where noise and outflow air emitted by the unit will not annoy neighbors.
2. Select a site where there is sufficient ventilation.
3. Select a site where there is no obstruction blocking the inlet and outlet.
4. The site should be able to withstand the full weight and vibration.
5. Select a dry place, but do not expose the unit to direct sunlight or strong wind.
6. Make sure that the outdoor unit is installed in accordance with the installation instructions, and is convenient for maintenance and repair.
7. The height difference between indoor and outdoor units is within 5 m, and the length of the connecting tubing does not exceed 10 m.
8. Select a place where it is out of reach of children.
9. Select a place where the unit does not have negative impact on pedestrians or on the city.

Safety Precautions for Electric Appliances

1. A dedicated power supply circuit should be used in accordance with local electrical safety regulations.
2. Don't drag the power cord with excessive force.
3. The unit should be reliably earthed and connected to an exclusive earth device by the professionals.
4. The air switch must have the functions of magnetic tripping and heat tripping to prevent short circuit and overload.
5. The minimum distance between the unit and combustible surface is 1.5m.
6. The appliance shall be installed in accordance with national wiring regulations.
7. An all-pole disconnection switch with a contact separation of at least 3mm in all poles should be connected in fixed wiring.

Note:

- Make sure the live wire, neutral wire and earth wire in the family power socket are properly connected. There should be reliable circuit in the diagram.
- Inadequate or incorrect electrical connections may cause electric shock or fire.

◆ Notices for Installation

Earthing Requirements

1. Air conditioner is type I electric appliance. Please ensure that the unit is reliably earthed.
2. The yellow-green wire in air conditioner is the earthing wire which can not be used for other purposes. Improper earthing may cause electric shock.
3. The earth resistance should accord to the national criterion.
4. The power must have reliable earthing terminal. Please do not connect the earthing wire with the following:
 - ① Water pipe
 - ② Gas pipe
 - ③ Contamination pipe
 - ④ Other place that professional personnel consider is unreliable
5. The model and rated values of fuses should accord with the silk print on fuse cover or related PCB.
6. Including an air switch with suitable capacity, please note the following table. Air switch should be included magnet buckle and heating buckle function, it can protect the circuit-short and overload. (Caution: please do not use the fuse only for protect the circuit)

Air-conditioner (W)	Air switch capacity
09K	16A
12K	16A
18K	25A

◆ Installation dimension diagram

Installation dimension diagram

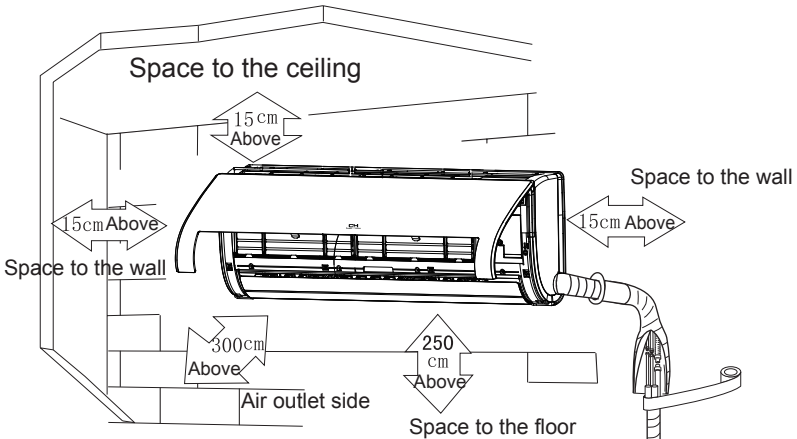

- The dimensions of the space necessary for proper installation of the unit include the minimum permissible distances to adjacent parts.

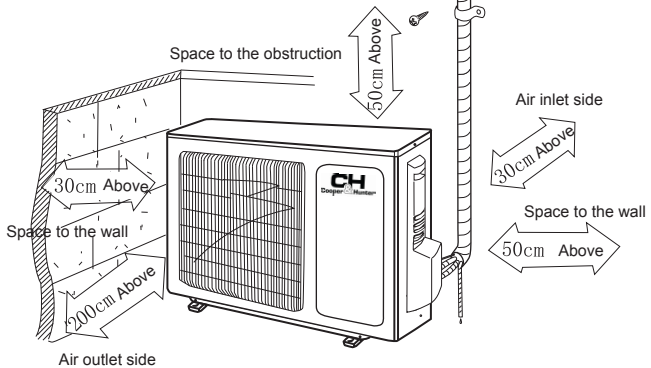

Installation of Indoor Unit

Installation of Mounting Plate

1. Mounting plate should be installed horizontally. As the water tray's outlet for the indoor unit is two-way type, during installation, the indoor unit should slightly slant to water tray's outlet for smooth drainage of condensate.
2. Fix the mounting plate on the wall with screws.
3. Be sure that the mounting plate has been fixed firmly enough to withstand about 60 kg. Meanwhile, the weight should be evenly shared by each screw.

09、12K UNIT:

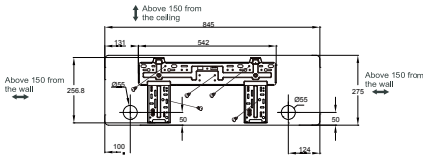

18K UNIT:

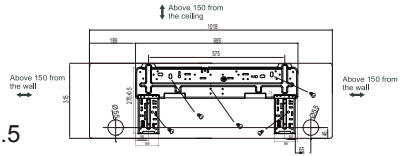
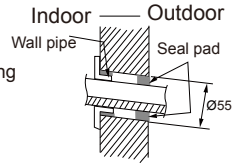

Fig.5

Drill Piping Hole

1. Slant the piping hole ($\phi 55$) on the wall slightly downward to the outdoor side.
2. Insert the piping-hole sleeve into the hole to prevent the connection piping and wiring from being damaged when passing through the hole.



Installation of Drain Hose

1. Connect the drain hose to the outlet pipe of the indoor unit. Bind the joint with rubber belt.
2. Put the drain hose into insulating tube.
3. Wrap the insulating tube with wide rubber belt to prevent the shift of insulating tube. Slant the drain hose downward slightly for smooth drainage of condensate.

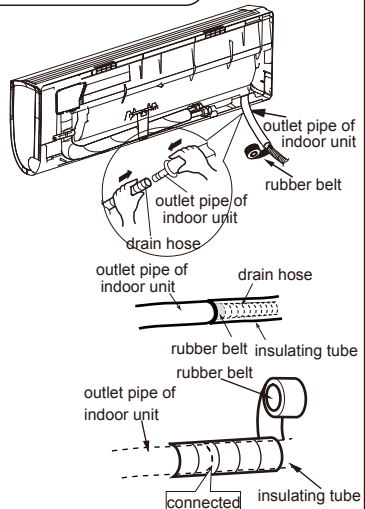

Note: The insulating tube should be connected reliably with the sleeve outside the outlet pipe. The drain hose should be slanted downward slightly, without distortion, bulge or fluctuation. Do not put the outlet in the water.

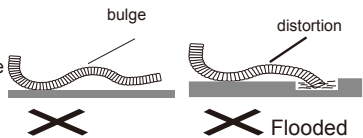

◆ Installation of Indoor Unit

Connecting Indoor and Outdoor Electric Wires

1. Open the front panel.
2. Remove the wiring cover and wire clamp. Make the power connection cord pass through the hole at the back of indoor unit.
3. Connect and fix the power connection cord to the terminal board. (As shown in Fig.6)
4. Fix the power connection cord with wire clamp and reinstall wiring cover.
5. Reinstall the front panel.

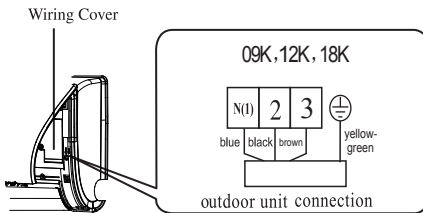

Fig.6

NOTE:

All wires between indoor and outdoor units must be connected by the qualified electric contractor.

- Electric wires must be connected correctly. Improper connection may cause malfunction.
- Tighten the terminal screws securely.
- After tightening the screws, pull the wire slightly to confirm whether it's firm or not.
- Make sure that the electric connections are earthed properly to prevent electric shock.
- Make sure that all wiring connections are secure and the cover plates are reinstalled properly. Poor installation may cause fire or electric shock.

◆ Installation of Indoor Unit

Installation of Indoor Unit

- The piping can be output from right, right rear, left or left rear.
- When routing the piping and wiring from the left or right side of indoor unit, cut off the tailings from the chassis when necessary (As shown in Fig.7)
 - Cut off tailing 1 when routing the wiring only;
 - Cut off tailing 1 and tailing 2 when routing both the wiring and piping.
 - Take out the piping from body case; wrap the piping, power cords, drain hose with the tape and then make them pass through the piping hole. (As shown in Fig.8)
 - Hang the mounting slots of the indoor unit on the upper hooks of the mounting plate and check if it is firm enough. (As shown in Fig.9)
 - The installation site should be 250cm or more above the floor.

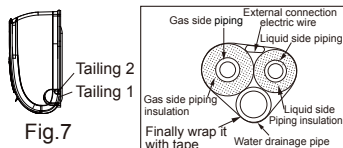

Fig.7

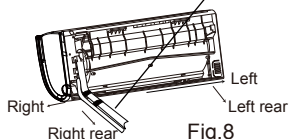

Fig.8

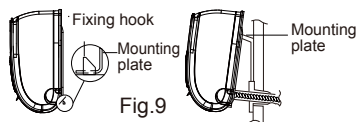

Fig.9

For 09、12K UNIT:

NOTE: Three situations (in front of the unit)

- Connecting left water outlet of the unit, drain pipe is laid on the left of the unit.
- Connecting to left or right water outlet, drain pipe is laid on the right of the unit.
- Connecting right water outlet of the unit, drain pipe goes through hole in the wall behind the indoor unit.

Installation of Connection Pipe

- Align the center of the pipe flare with the related valve.
- Screw in the flare nut by hand and then tighten the nut with spanner and torque wrench by referring to the following:

Hex nut diameter	Tightening torque (N·m)
Φ6	15~20
Φ 9.52	30~40
Φ 12	45~55
Φ 16	60~65
Φ 19	70~75

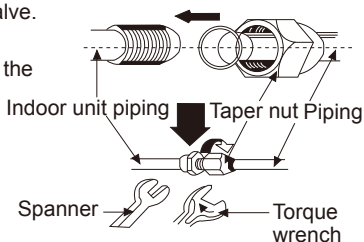

NOTE: Connect the connection pipe to indoor unit at first and then to outdoor unit. Handle piping bending with care. Do not damage the connection pipe. Ensure that the joint nut is tightened firmly, otherwise, it may cause leakage.

◆ Installation of Outdoor Unit

Electric Wiring

1. Remove the handle on the right side plate of outdoor unit.
2. Take off wire clamp. Connect and fix power connection cord to the terminal board. Wiring should fit that of indoor unit.
3. Fix the power connection cord with wire clamp.
4. Confirm if the wire has been fixed properly.
5. Reinstall the handle.

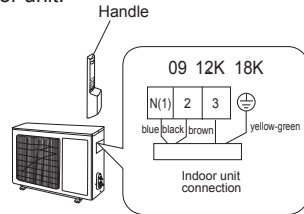

NOTE:

- Incorrect wiring may cause malfunction of spare part.
- After the wire has been fixed, ensure there is free space between the connection and fixing places on the lead wire.

Schematic diagram being reference only, please refer to real product for authentic information.

Air Purging and Leakage Test

1. Connect charging hose of manifold valve to charge end of low pressure valve (both high/low pressure valves must be tightly shut).
2. Connect joint of charging hose to vacuum pump.
3. Fully open the handle of Lo manifold valve.
4. Open the vacuum pump for vacuumization. At the beginning, slightly loosen joint nut of low pressure valve to check if there is air coming inside (If noise of vacuum pump has been changed, the reading of multimeter is 0). Then tighten the nut.
5. Keep vacuuming for more than 15mins and make sure the reading of multi-meter is -1.0×10^5 pa (-76cmHg).
6. Fully open high/low pressure valves.
7. Remove charging hose from charging end of low pressure valve.
8. Tighten lid of low pressure valve. (As shown in Fig.10)

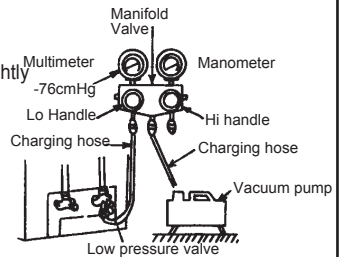
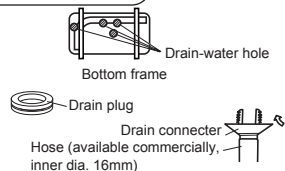

Fig.10

Outdoor Condensate Drainage (only for Heat pump unit)

During heating operation, the condensate and defrosting water should be drained out reliably through the drain hose.

Install the outdoor drain connector in a $\varnothing 42$ hole on the base plate and attach the drain hose to the connector so that the waste water formed in the outdoor unit can be drained out .The hole diameter 42 must be plugged.



Whether to plug other holes will be determined by the dealers according to actual conditions.

◆ Check after Installation and Operation Test

Check after Installation

Items to be checked	Possible malfunction
Has the unit been fixed firmly?	The unit may drop, shake or emit noise.
Have you done the refrigerant leakage test?	It may cause insufficient cooling(heating)
Is thermal insulation sufficient?	It may cause condensation.
Is water drainage satisfactory?	It may cause water leakage.
Is the voltage in accordance with the rated voltage marked on the nameplate?	It may cause electric malfunction or damage the unit.
Is the electric wiring or piping connection installed correctly and securely?	It may cause electric malfunction or damage the parts.
Has the unit been securely earthed?	It may cause electrical leakage.
Is the power cord specified?	It may cause electric malfunction or damage the parts.
Is the inlet or outlet blocked?	It may cause insufficient cooling(heating)
Is the length of connection pipes and refrigerant capacity recorded?	The refrigerant capacity is not accurate.

Operation Test

1. Before Operation Test

- (1) Do not switch on power before installation is finished completely.
- (2) Electric wiring must be connected correctly and securely.
- (3) Cut-off valves of the connection pipes should be opened.
- (4) All the impurities such as scraps and thrums must be cleared from the unit.

2. Operation Test Method

- (1) Switch on power and press "ON/OFF" button on the remote controller to start operation.
- (2) Press MODE button to select the COOL, HEAT (Not available for cooling only unit), FAN to check whether the operation is normal or not.

◆ Installation and Maintenance of Healthy Filter(Optional)

Installation of Healthy Filter

1. Lift up the front panel from its two ends, as shown by the arrow direction, and then remove the air filter. (as shown in Fig.a)

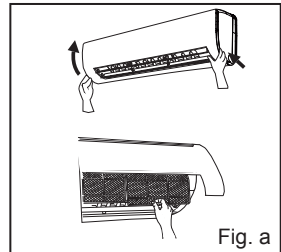

2. Attach the healthy filter onto the air filter, (as shown in Fig.b).

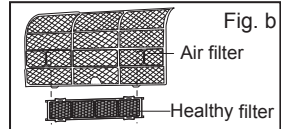

3. Install the air filter properly along the arrow direction in Fig.c, and then close the panel .

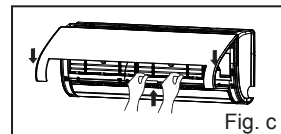

Cleaning and Maintenance

Remove the healthy filter and reinstall it after cleaning according to the installation instruction. Do not use brush or hard objects to clean the filter. After cleaning, be sure to dry it in the shade.

Service Life

The general service life for the healthy filter is about one year under normal condition. As for silver ion filter, it is ineffective when its surface becomes black (green).

- This supplementary instruction is provided for reference to the unit with healthy filter. If the graphics provided herein are different from the actual product, please refer to the actual product. The quantity of healthy filters is based on the actual delivery.

◆ Configuration of connection pipe and additional volume of refrigerant

1. Standard length of connection pipe

5m、7.5m、8m

2. Min length of connection pipe

For the unit with standard connection pipe of 5m, there is no limitation for the min length of connection pipe. For the unit with standard connection pipe of 7.5m and 8m, the min length of connection pipe is 3m.

3. Max length of connection pipe

Sheet 1 Max length of connection pipe Unit: m

Capacity	Max length of connection pipe		Capacity	Max length of connection pipe
5000 Btu/h (1465 W)	15		24000 Btu/h (7032 W)	25
7000 Btu/h (2051 W)	15		28000 Btu/h (8204 W)	30
9000 Btu/h (2637 W)	15		36000 Btu/h (10548 W)	30
12000 Btu/h (3516 W)	20		42000 Btu/h (12306 W)	30
18000 Btu/h (5274 W)	25		48000 Btu/h (14064 W)	30

4. The calculation method of additional refrigerant oil and refrigerant charging amount after prolonging connection pipe

After the length of connection pipe is prolonged for 10m at the basis of standard length, you should add 5ml of refrigerant oil for each additional 5m of connection pipe.

The calculation method of additional refrigerant charging amount (on the basis of liquid pipe):

- (1) Additional refrigerant charging amount = prolonged length of liquid pipe × additional refrigerant charging amount per meter
- (2) When the length of connection pipe is above 5m, add refrigerant according to the prolonged length of liquid pipe. The additional refrigerant charging amount per meter is different according to the diameter of liquid pipe. See Sheet 2.

◆ Configuration of connection pipe and additional volume of refrigerant

Sheet 2. Additional refrigerant charging amount for R22, R407C, R410A and R134a

Diameter of connection pipe mm		Indoor unit throttle	Outdoor unit throttle	
Liquid pipe	Gas pipe	Cooling only, cooling and heating (g / m)	Cooling only (g / m)	Cooling and heating (g / m)
Φ6	Φ9.5 or Φ12	20	15	20
Φ6 or Φ9.5	Φ16 or Φ19	50	15	50
Φ12	Φ19 or Φ22.2	100	30	120
Φ16	Φ25.4 or Φ31.8	170	60	120
Φ19	-	250	250	250
Φ22.2	-	350	350	350

Note: The additional refrigerant charging amount in Sheet 2 is recommended value, not compulsory.

Designed by Cooper&Hunter International Corporation, Oregon, USA
www.cooperandhunter.com
E-mail: info@cooperandhunter.com



66162669