

**Saramonic®**

5.8GHz Wireless  
Microphone System  
VmicLink5

---

### **Statement**

Please read this manual carefully before using and strictly operate and store in accordance with the instructions. Please save it for your future reference.

If the user manual can not help you to solve certain problems, please ask your retailer for help or email us: **info@saramonic.com**.

---

### **Cautions**

1. Do not use the unit under water, don't expose it to rain.  
Please store it in a cool, dry place.
2. Please use and store it in normal temperature. Do not move it from overheated to supercooled condition frequently as well as keep away from heat sources such as heater and oven.
3. When using and storing, please pay attention to dust and moisture.
4. Be careful to violent collision.
5. To avoid acoustical feed-back, do not hold the microphone close to the loudspeakers.
6. For the best sound pick-up pattern do not hold your hand against the microphone head.
7. Remove the batteries from the battery compartment when the device is not used for a long time.

---

## Contents

---

<b>General Introduction</b>	<b>2</b>
-----------------------------	----------

---

<b>Highlights</b>	<b>2</b>
-------------------	----------

---

<b>Portable Receiver VmicLink5-RX</b>	<b>2</b>
Product Structure	2
Attaching Accessories	3
LCD Display Operation Guide	3

---

<b>Body-pack Transmitter VmicLink5-TX</b>	<b>5</b>
Product Structure	5
Attaching Accessories	6
LCD Display Operation Guide	6

---

<b>Battery Charger</b>	<b>8</b>
------------------------	----------

---

<b>Specifications</b>	<b>8</b>
-----------------------	----------

---

<b>Packing List</b>	<b>9</b>
---------------------	----------

---

<b>Package</b>	<b>9</b>
----------------	----------

## 1 General Introduction

The Saramonic VmicLink5 wireless microphone system utilizes the new 5.8GHz transmission technology to transfer high quality audio.

One receiver can work with up to three transmitters simultaneously, which is very useful and flexible for audio recording in DSLR video, field recording, filmmaking, broadcast & TV, electric news gathering (ENG), on-the-spot interviews, sound design and more.

## 2 Highlights

- The 5.8GHz provides high quality audio.
- Record audio up to 30 meters away with no obstacle.
- Automatic channel switch programme to avoid interference from multiple systems in the same environment.
- With three discrete channel groups.
- One receiver can work with up to three transmitters simultaneously.
- Line & Mic inputs provide wide range of input options.
- Real-time headphone monitor jack.
- Detachable and flexible antenna can be rotated 360° accordingly for best sound.
- Rechargeable li-ion battery (included).

## 3 Portable Receiver VmicLink5-RX

The Saramonic VmicLink5-RX is a camera-mountable integrated wireless receiver. It features an easy-to-read LCD display and DigRF synchronization between transmitter and receiver.

The selectable output mode allows you to choose the output signal to be mono or stereo.

## 3.1 Product Structure

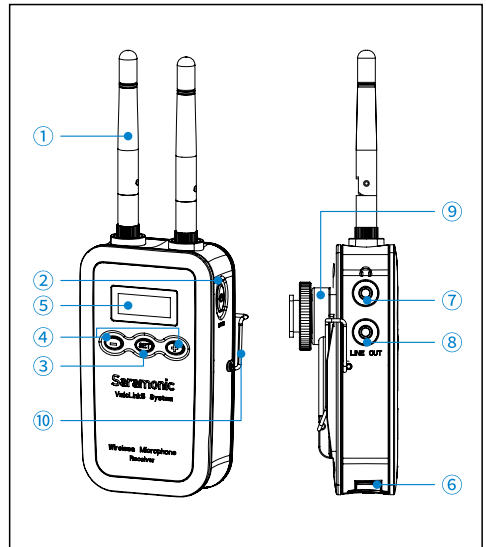

### ① Antennas

Screw clockwise to install.

Screw counterclockwise to dismantle.

Adjust the antennas accordingly to get the best sound reception.

### ② Power / Mute button

Function	Operation
Power ON	Press button for one second or longer
Power OFF	Press button until it turns off
Mute ON	Short press button
Mute OFF	

### ③ SET button

Long press the SET button to enter the displayed menu.

Then, short press the SET button to confirm your option or long press again to exit without saving.

### ④ + or - button

Select functions or values shown on the display.

### ⑤ LCD display

Display menus, please refer to "1.3.3 LCD Display Operation Guide" (page 3) for more details.

### ⑥ Battery compartment

Install battery:

Slide the switch on the battery compartment cover according to the indicating arrow to open the battery compartment.

Install a battery properly and the battery will be locked automatically. Slide the switch to close the battery compartment.

Remove a battery:

Slide the switch on the battery compartment cover according to the indicating arrow to open the battery compartment. Slide the battery locking unit to release the battery.

### ⑦ PHONE jack

3.5mm stereo mini headphone jack.

Connect a headphone to monitor the audio output.

### ⑧ LINE out jack

Connect the RX to a video camera, camcorder, mixer or amplifier with the supplied output cable.

### ⑨ Standard mount cold shoe

### ⑩ Belt clip

## 3.2 Attaching Accessories

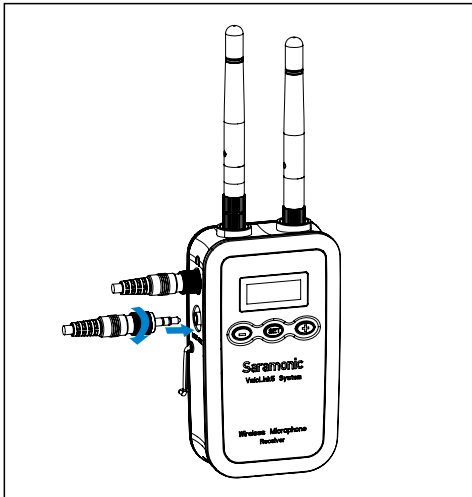

## Connect the supplied cable to the Line out

- Plug the supplied 3.5mm cable into the LINE OUT.
- For a secure connection, rotate clockwise to lock the connector.

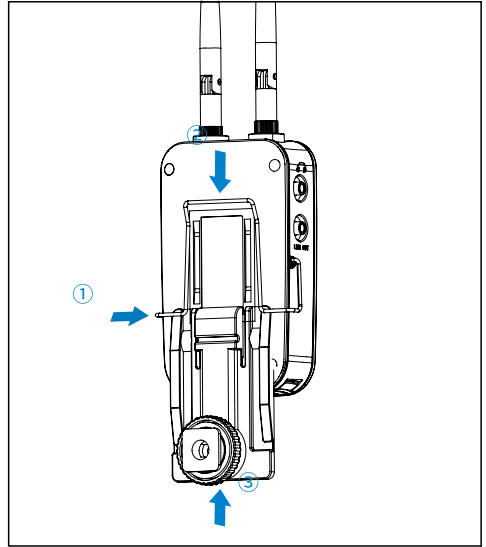

## Attach the shoe mount adapter

- ① Please attach the belt clip upside-down before attaching the shoe mount adapter.
- ② Push the bottom of the belt clip to make some space between the belt clip and the receiver.
- ③ Align the belt clip with the two vertical grooves on the shoe mount adapter and insert the adapter in the direction of the arrow. Push the shoe mount adapter in fully until the belt clip fits into the horizontal groove on the adapter holds.

## 3.3 LCD Display Operation Guide

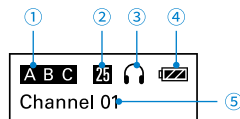

## Home screen

If no operation is performed for 20 seconds on the other screens, the display will automatically return to the home screen.

### ① RX & TX connecting indicator

"---": The RX hasn't been matched with a TX in this group.

"A" or "B" or "C" flashing: The RX has been matched but hasn't been connected with the TX in this group.

"A" or "B" or "C" solid: The RX has been matched with the TX successfully in this group.

**NOTE:** Details please refer to "Match with TX" & "Match with RX" (page 4/7).

### ② Volume indicator

Indicates the volume of audio output.

### ③ Mute indicator

 MUTE ON  MUTE OFF

**NOTE:** MUTE on RX will mute the output audio.

### ④ Battery level indicator

Displays the battery level. Please replace both batteries immediately when the indicator starts flashing.

**NOTE:** Low battery might cause an unstable transmission of audio signal.

### ⑤ Current channel

Displays the current channel number.

**NOTE:** The channel can only be changed manually in the RX.

Once the RX is matched with the TX(s), the channel number of TX(s) will be changed with RX synchronously all the time.

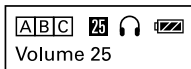

### Set output volume

Long press the SET button to enter the menu. Use the "+" and "-" to set the volume of output audio within the range 0 to 31, short press for exit with saving. The setting is retained even after the power is turned off.

- Default is "25."

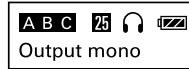

### Output mode

The output mode can be selected to mono or stereo.

When the output mode is mono, the audio from left and right channel will be mixed. When it is stereo, the left and right audio channel output will be separated.

In Stereo mode, the audio of group A & C will be output to left channel, the audio of Group B will be output to right channel.

- Default is "mono."

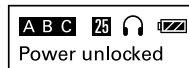

### Power locked / unlocked

Long press the SET button to enter the menu. Use the "+" and "-" to set unlocked or locked the power key. Lock the power key to prevent the receiver being turned off unwittingly while using.

- Unlocked: Long press the power key to turn on/off the receiver (System default).
- Locked: The receiver will not be turned off even after pressing the power key.

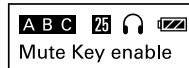

### Mute key enable / disable

Long press the SET button to enable / disable Mute function.

- Enable: Press power button to turn Mute On / Off.
- Disable: The audio will not be muted during using.
- Default is "enable."

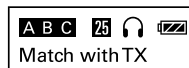

### Match with TX

Long press the SET button to enter "Match with TX". Then, short press to start "Match with TX" in the RX and "Match with RX" in the TX simultaneously to match the TX with RX.

The RX can't match with two or three TXs

simultaneously, please match the RX with TX(s) one by one.

According to the chronological order of matching, the group number of each TX(s) will be A, B, C by turns.

**NOTE:** Please match the TX and RX if they haven't been matched before.

Once RX and TX have been matched successfully, the setting is retained even after the power is turned off.

The RX and TX will automatically match with each other everytime after powered on.

When need to relieve TX and RX connection, select and confirm "Restore default" menu.

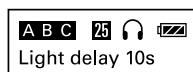

### Set backlight

Select ON, OFF or Delay 10 / 30 /60 seconds. Default is "Delay 10s."

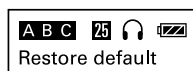

### Restore settings

Confirm it then the parameters of RX are restored to their factory default settings.

**NOTE:** The matching setting will also be cleared after restoring.

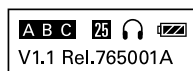

### Version of the RX

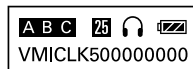

### Serial number

## 4 Body-pack Transmitter VmicLink5-TX

The VmicLink5-TX is a compact transmitter that employs a crystal-controlled PLL synthesizer. It is equipped with a muting function and lock-type Mic and Line input connectors.

### 4.1 Product Structure

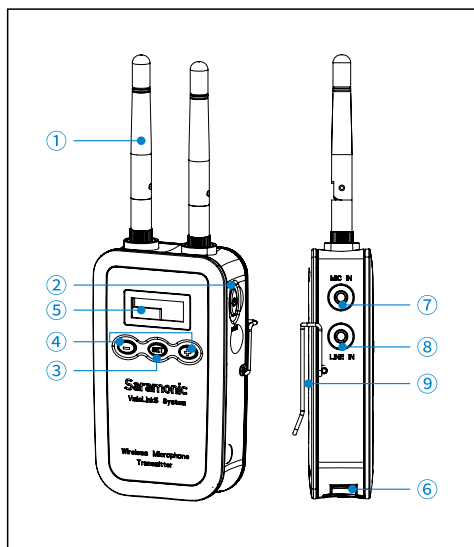

#### ① Antennas

Screw clockwise to install.

Screw counterclockwise to dismantle.

Adjust the antennas accordingly to deliver the best transmission.

#### ② Power / Mute button

Function	Operation
Power ON	Press button for one second or longer
Power OFF	Press button until it turns off
Mute ON	Short press button
Mute OFF	

#### ③ SET button

Long press the SET button to enter the displayed menu.

Then, short press the SET button to confirm your option or long press again to exit without saving.

#### ④ + or - button

Select functions or values shown on the display.

#### ⑤ LCD display

Display menus, please refer to "1.4.3 LCD Display Operation Guide" for more details.

#### ⑥ Battery compartment

Install and remove the battery instructions are the same as receiver.

#### ⑦ Mic input jack

Connect to the supplied lavalier microphone.

#### ⑧ Line input jack

Connect to audio devices with line output.

#### ⑨ Belt clip

### 4.2 Attaching Accessories

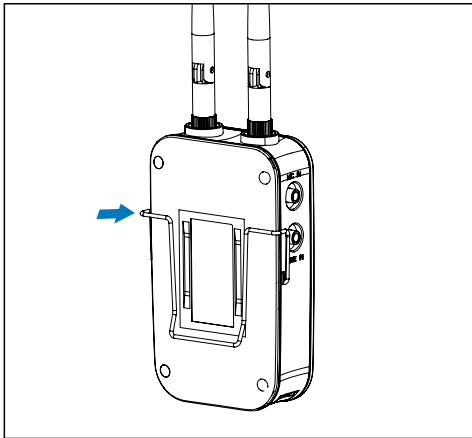

#### Attach a belt clip

Insert one end of the belt clip into one of two holes on either side of the transmitter, and then insert the other end into the hole on the other side.

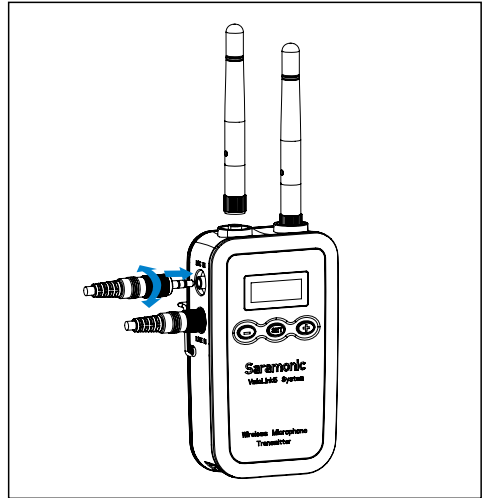

#### Connect the supplied cable to the Line out

- Connect the microphone / audio device.
- For a secure connection, turn to lock the connector.

**NOTE:** Please turn off the transmitter before attaching or removing the microphone / audio device.

### 4.3 LCD Display Operation Guide

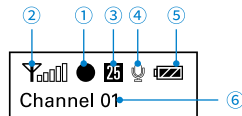

#### Home screen

If no operation is performed for 20 seconds on the other screens, the display will automatically return to the home screen.

#### ① RX & TX connecting indicator

"A or B or C": The TX has been matched with the RX successfully.

"○" & "●" flashing: The TX hasn't been matched with the RX.

**NOTE:** Details please refer to "Match with TX" & "Match with RX" (page 4/7).

#### ② RF level indicator

Indicates the current transmission level.



### ③ Volume indicator

Indicates the volume of audio output.

### ④ Mute indicator

 MUTE ON     MUTE OFF

**Note:** If turn on Mute of the TX, only this TX will be muted.

### ⑤ Battery level indicator

Displays the battery level. Please replace the battery immediately when the indicator starts flashing.

**NOTE:** Low battery might cause an unstable transmission of audio signal.

### ⑥ Current channel

Displays the current channel number.

**NOTE:** The channel can only be changed manually in the RX.

Once the RX is matched with the TX(s), the channel number of TX(s) will be changed with RX synchronously all the time.



#### Volume setting

Long press the SET button to enter the menu. Use the "+" and "-" to set the volume of output audio within the range 0 to 31, short press for exit with saving. The setting is retained even after the power is turned off.

- Default is "25."



#### Power locked/ unlocked

Long press the SET button to enter the menu. Use the "+" and "-" to set unlocked or locked the power key. Lock the power key to prevent the receiver being turned off unwittingly while using.

- Unlocked: Long press the power key to turn on/off the receiver (System default).
- Locked: The receiver will not be turned off even after pressing the power key.

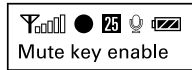

#### Mute key enable / disable

Long press the SET button to enable / disable Mute function.

- Enable: Press power button to turn Mute On / Off.
- Disable: The audio will not be muted during using.
- Default is "enable."

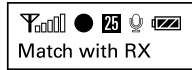

#### Match with RX

- Long press the SET button to enter "Match with RX". Then, short press to start "Match with TX" in the RX and "Match with RX" in the TX simultaneously to match the TX with RX.
- The RX can't match with two or three TXs simultaneously, please match the RX with TX(s) one by one.
- According to the chronological order of matching, the group number of each TX(s) will be A, B, C by turns.

**NOTE:** Please match the TX and RX if they haven't been matched before  
Once RX and TX has been matched successfully, the setting is retained even after the power is turned off.  
The RX and TX will automatically match with each other everytime after powered on.  
When need to relieve TX and RX connection, select and confirm "Restore default" menu.



#### Set backlight

Set the background LED light to ON or Delay 60/30/10 seconds or OFF.

Default is "Delay 10s."



### Restore default setting

Restore all settings of the TX to default settings.

**NOTE:** The matching setting will also be cleared after restoring.



### Version of the TX



### Serial number

## 5 Battery Charger

Use the battery charger to recharge the battery of VmicLink5 system.

The indicator turns red while the battery is charging.

The indicator turns green while the battery has been fully charged.

## 6 Specifications

VmicLink5 System	
RF power	15dBm(30mW)
RF frequency	5725-5875MHz
Channel	3CH, RX channel changeable, TX follow with RX
Transmission distance	30m with no obstacle
Interface	Transmitter Mic in: Max 160mV/-13dBu, 1.8V phantom power
	Transmitter Line in: Max 2V/8dBu, 50V DC isolation
	Receiver Phone out: Max 70mW/32Ω, 10V DC isolation
	Receiver Line out: 4 times mic in gain, 50V DC isolation
Receive sensitivity	98dB
THD+N	-92dB
Sample rate	48K/16bit

Audio frequency response	40Hz-18KHz±1dB
Voice delay	18ms
Power consumption	RX: 180mA/6V
	TX: 140mA/6V
Antenna gain	3dBi
Weight	810g
Battery	7.2V/1000mAh Li-ion
Battery type	LP-E17(CANON EOS M3/750D/760D)
Dimensions	RX: 113x64x28mm
	TX: 113x64x28mm
Operating temperature	0°C-50°C
Storage temperature	-20°C-55°C

## 7 Packing List

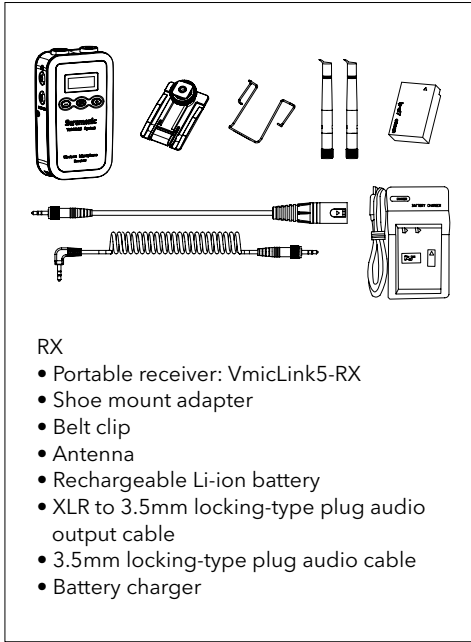

### RX

- Portable receiver: VmicLink5-RX
- Shoe mount adapter
- Belt clip
- Antenna
- Rechargeable Li-ion battery
- XLR to 3.5mm locking-type plug audio output cable
- 3.5mm locking-type plug audio cable
- Battery charger

## 8 Package

### VmicLink5 RX+TX

This package includes one receiver RX and one transmitter TX.

### VmicLink5 RX+TX+TX

This package includes one receiver RX and two transmitters TX.

### VmicLink5 RX+TX+TX+TX

This package includes one receiver RX and three transmitters TX.

**NOTE:** The RX and TX in different packages can be matched.

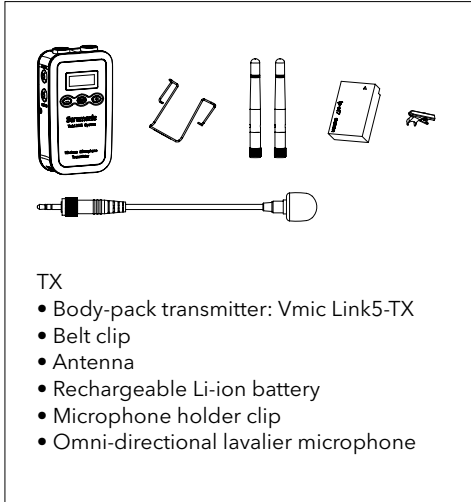

### TX

- Body-pack transmitter: Vmic Link5-TX
- Belt clip
- Antenna
- Rechargeable Li-ion battery
- Microphone holder clip
- Omni-directional lavalier microphone

- Warranty card
- User manual

**[www.saramonic.com](http://www.saramonic.com)**

The Saramonic logo is trademark which is registered and owned by Saramonic International.

COPYRIGHT 2011-2021 SARAMONIC INTERNATIONAL ( A brand of DSQN )

Email: [info@saramonic.com](mailto:info@saramonic.com)