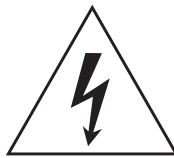
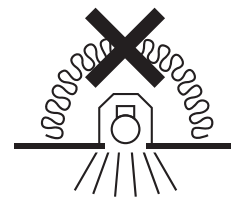
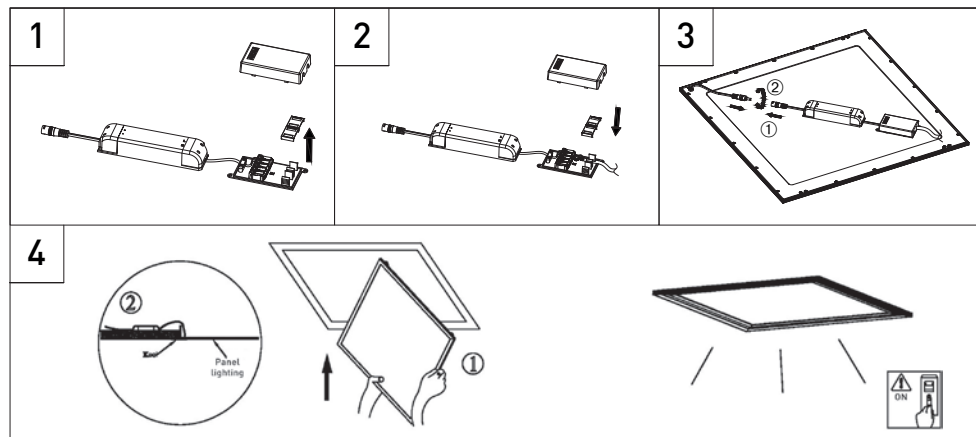

PLATA / PLATA MP

IP20

-O- ta
40 °C

MODUULIVALAISIN | MODULARMATUR | MODULAR LUMINAIRE

-o- 5 x 2,5 mm²

Valaisinta ei saa asentaa suoraan eristemateriaaliin.

Denna armatur är inte avsedd för att täckas med värmeisolerande material.

The luminaire is not suitable for covering with thermally insulated material.

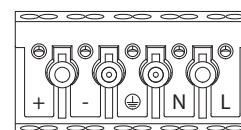
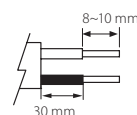
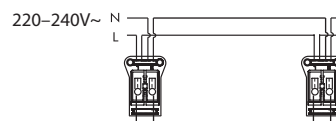
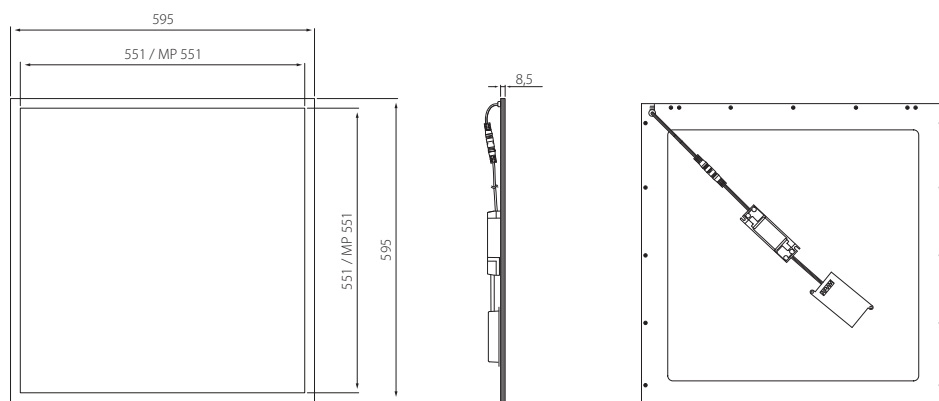

DA DA E
+ -

E = Maadoituksen jatkaminen / päättyminen
E = Anslutning / avslutning av jordningsledning
E = Continuity / termination of earth wires

SNRO	KOODI/CODE	PLATA	KG	GTIN	E-NR
4209517	A2PLCD	PLATA 30W/830 VA	2,2	6435200232762	7014607
4209518	A2PLCE	PLATA 30W/840 VA	2,2	6435200232779	7014608
4209519	A2PLCF	PLATA 30W/830 VA DA	2,2	6435200232786	7014609
4209520	A2PLCG	PLATA 30W/840 VA DA	2,2	6435200232793	7014610
4289990	A2PLLA	PLATA 40W/830 VA	2,2	6435200216908	7013299
4289991	A2PLLB	PLATA 40W/840 VA	2,2	6435200216915	7013300
4289992	A2PLLC	PLATA 40W/830 DALI VA	2,2	6435200216922	7013301
4289993	A2PLLD	PLATA 40W/840 DALI VA	2,2	6435200216939	7013302

SNRO	KOODI/CODE	PLATA MP	KG	GTIN	E-NR
4209521	A2PLMA	PLATA 33W/830 MP VA	2,2	6435200232809	7014611
4209522	A2PLMB	PLATA 33W/840 MP VA	2,2	6435200232816	7014613
4209523	A2PLMC	PLATA 33W/830 MP VA DA	2,2	6435200232823	7014618
4209524	A2PLMD	PLATA 33W/840 MP VA DA	2,2	6435200232830	7014619
4209525	A2PLME	PLATA 40W/830 MP VA	2,2	6435200232847	7014620
4209526	A2PLMF	PLATA 40W/840 MP VA	2,2	6435200232854	7014621
4209527	A2PLMG	PLATA 40W/830 MP VA DA	2,2	6435200232861	7014622
4209528	A2PLMH	PLATA 40W/840 MP VA DA	2,2	6435200232878	7014623
4222765	A2PLMI	PLATA 43W/830 MP VA	2,2	6435200244536	7015808
4222766	A2PLMJ	PLATA 43W/840 MP VA	2,2	6435200244543	7015809
4222767	A2PLMK	PLATA 43W/830 MP VA DA	2,2	6435200244550	7015810
4222768	A2PLML	PLATA 43W/840 MP VA DA	2,2	6435200244567	7015813

4289994	A2PLKE	PLATA PINTA-ASENNUSKEHYS	1,5	6435200216946	7910300
4289995	A2PLVS	PLATA VAJERRIPUSTUSSARJA	-	6435200216953	7910301

Valaisimen saa asentaa vain sähköalan ammattilainen. Käytä ainoastaan syöttöjännitettä ja taajuutta joka on merkitty valaisimeen/liitälaitteeseen. Kytke virta pois päältä ennen asennusta tai huoltoa. Tämä asennusohje on säilytettävä ja sen on oltava käytössä asennuksessa ja huollossa. Tämän valaisimen valonlähde ei ole vaihdettavissa. Kun valonlähde rikkoutuu, koko valaisin on poistettava käytöstä.

Vi rekommenderar att installationen görs av en behörig elektriker. Använd endast driftspänning och frekvens som är märkt på armaturen/förkopplingsdonet. Bryt strömmen före installation eller service. Denna monteringsanvisning bör sparas och finnas tillgänglig vid installation eller framtida service. Ljuskällan till denna armatur kan inte bytas ut. När ljuskällan når sin livslängd ska hela armaturen bytas ut.

Only a professional electrician is allowed to do the installation. Use only rated voltage and frequency as marked in the fixture/driver. Switch off the current before installation or service. This mounting instruction must be kept available during installation and for future maintenance. The light source of this luminaire is not replaceable; when the light source reaches its end of life the whole luminaire shall be replaced.

PLATA DALI

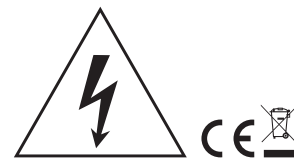

SPECIFICATION FOR 50W DALI DIMMABLE LED DRIVER

INPUT	Input voltage	220-240Vac, 50/60Hz
	Power factor (PF)	≥0.9 @ 240V AC input, full load and without dimmer
	Efficiency	≥87% @ 240V AC input, full load and without dimmer
	Stand-by power	<0.5 W
OUTPUT	No-load voltage	68V DC max
	Output current	700 mA (6-58V) 800 mA (6-58V) 900 mA (6-56V) 1050 mA (6-48V) 1200 mA (6-41V) 1300 mA (6-38V) 1400 mA (6-36V)
	Current accuracy	±5%
	Rated power	50W max
	Flicker rate	Less than 2%
DIMMING	Dimming mode	DALI (DALI 2 program), 1-10V, PUSH DIM
	Dimming range	2%-100%
ENVIRONMENT	Working temperature	-25 °C ~ 50 °C, Tc: 85 °C
	Storage temperature	-40 °C ~ 80 °C
SAFETY AND EMC	Insulation class	Class II, SELV
	Withstand voltage	Input-Output: 3.75kV AC / 5 mA / 1 min
PROTECTION	Short circuit	Protection mode: Auto recovery
	Overload	Protection mode: Auto recovery
	Over temperature	Protection mode: Auto recovery
	IP rating	IP20
	Connection	Input: Press-in terminals L, N, Earth, DA+, DA-, 1-10V+, 1-10V Output: Press-in terminals +,-
	Life time	50 000 h (MTBF 100 000 hours)

PLATA DALI

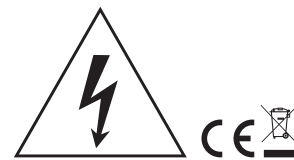

Kyt Kentä

230V ~

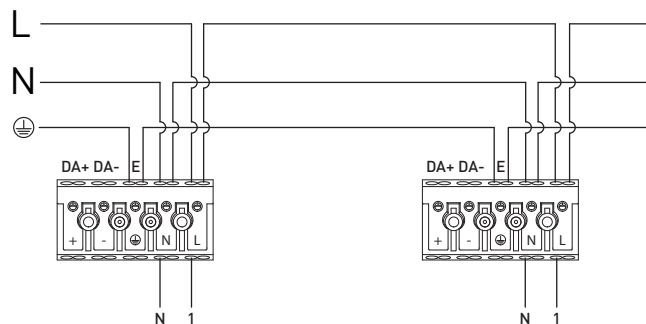

Kolmivaihekyt Kentä

230V ~

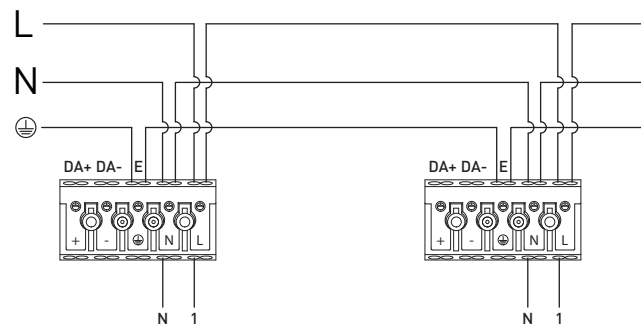

PUSH DIM

